



ASCLASS

ASCLASS CERRAHİ ALETLER İMALAT SAN. VE TİC. LTD.ŞTİ

📍 Çatalarmut Mahallesi Sezgin Sokak No:7 Kat:1/2/3 İlkadım/SAMSUN

📱 asclasscerrahialetler.ve.medya 🌐 Asclass cerrahi aletler 🌐 www.asclassgrup.com 📧 info@asclassgrup.com - asclassmedya@gmail.com

ÜRÜN GRUPLARIMIZ

- » Genel Cerrahi
- » Beyin Cerrahi
- » Ortopedi Cerrahi
- » Göz Cerrahi
- » Kulak Burun Boğaz
- » Jinekoloji
- » Üroloji
- » Kalp Damar
- » Üniversal Ekartör Setleri
- » Laparoskopik Ekartör Setleri
- » Laparoskopik El Aletleri
- » Steril Konteynir Sistem

54

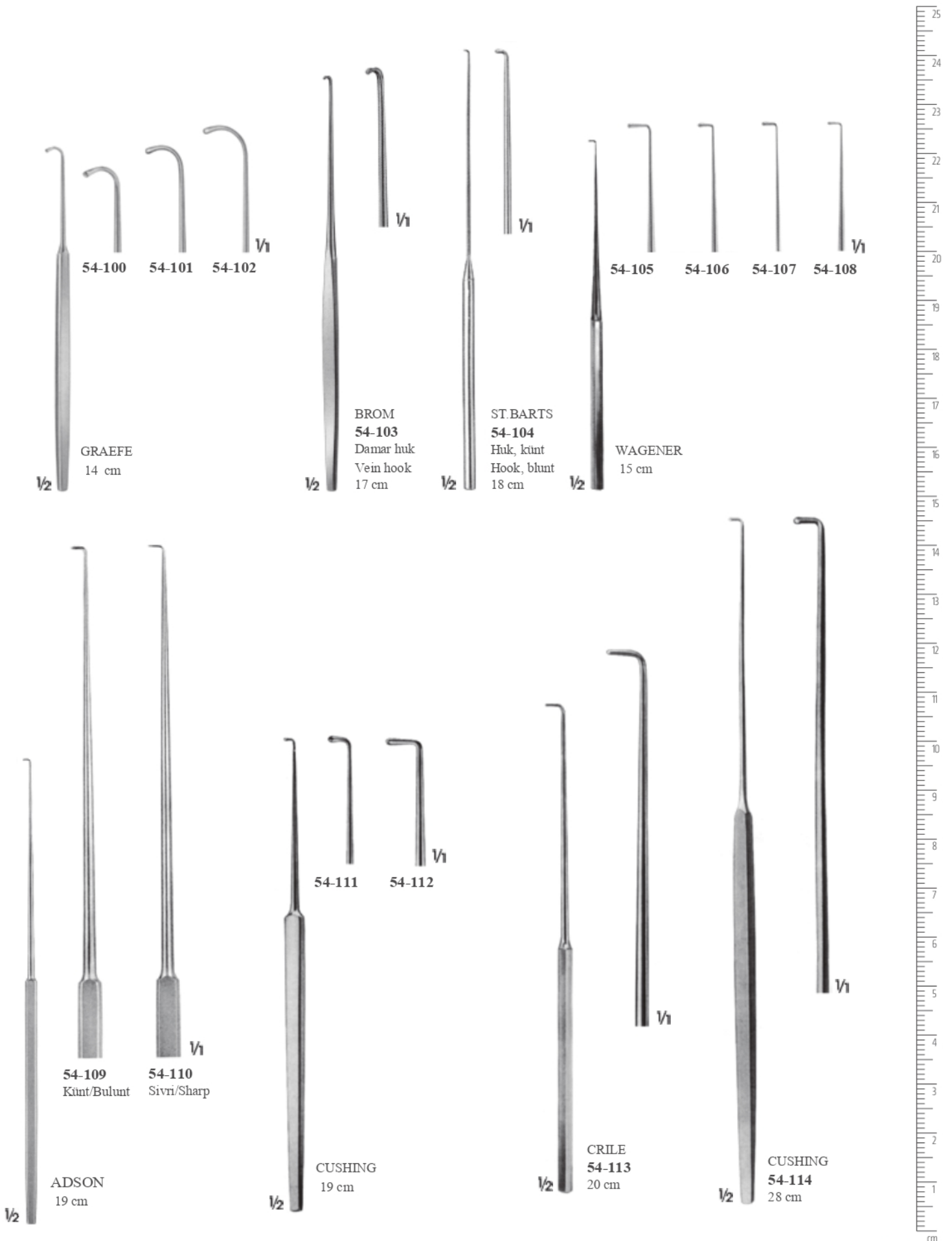

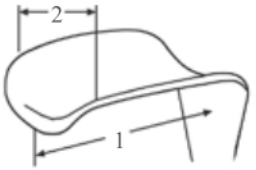

	<p>Ekartörler için ölçü sistemiM</p> <p>Derinlik :1 Genişlik :2</p> <p>Örnek:1 x 2</p>	<p>Measurement system for retractor blades</p> <p>Depth:1 Width :2</p> <p>Example:1 x 2</p>
---	--	---

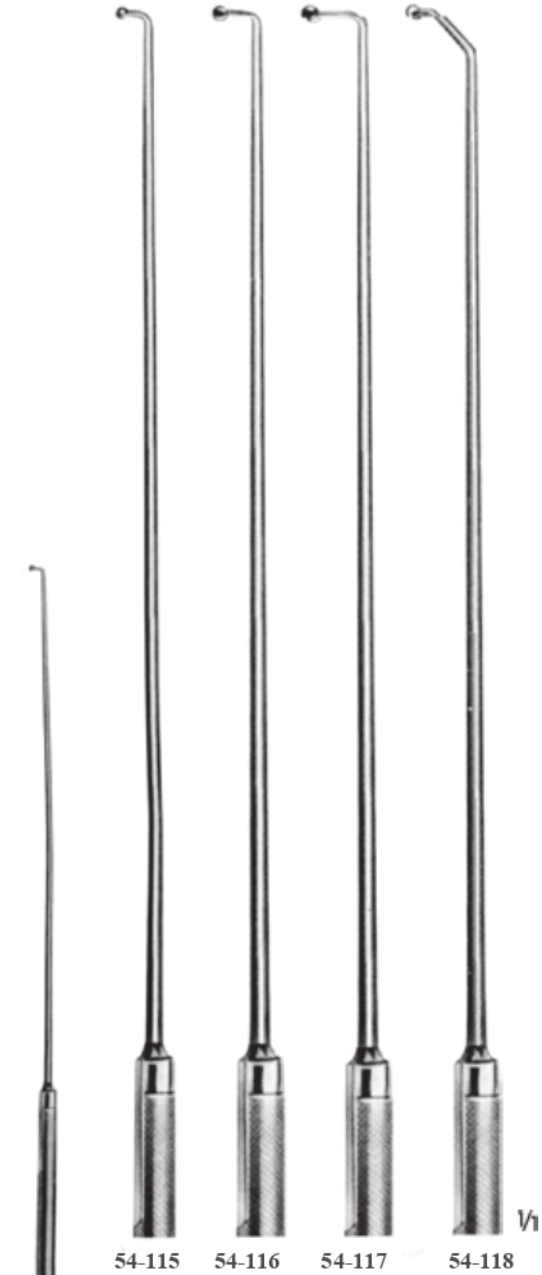

CASPAR
Keşif prob uçlu, huklar
Exploration hooks, probe-ended
24.5 cm

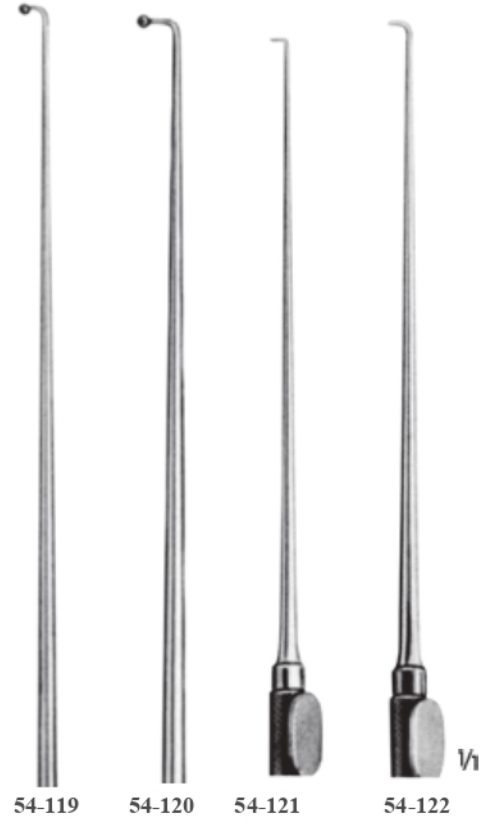

KRAYENBÜLH
18.5 cm

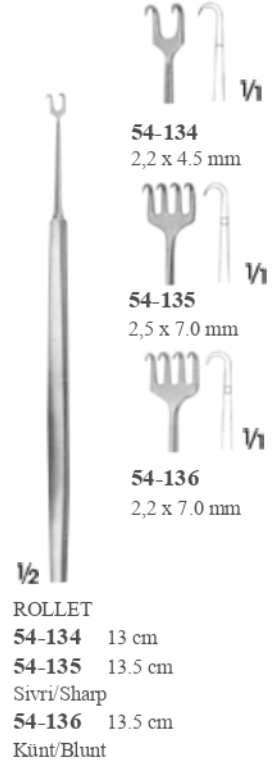
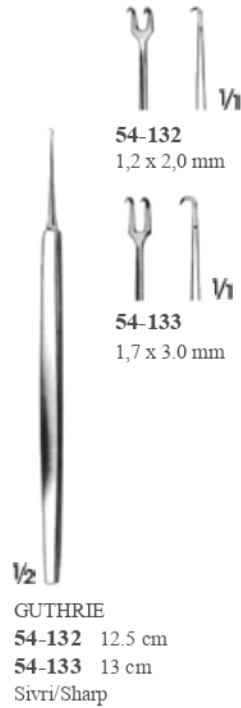
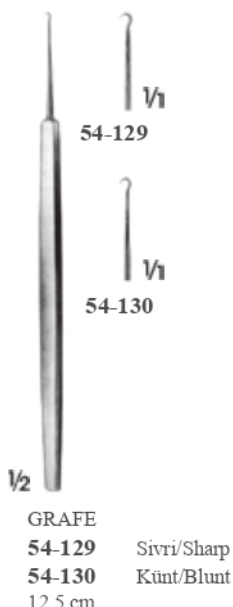
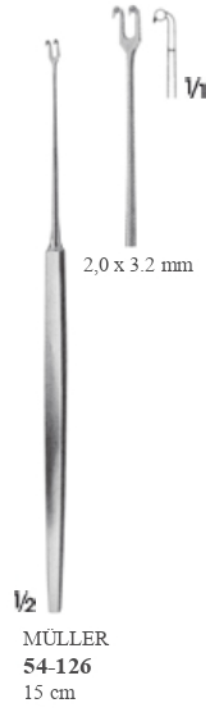



BERGMANN
54-137
14 cm



54-138



BOSE
54-139
16.5 cm



18 cm



54-141
Künt/Blunt



54-140
Sivri/Sharp



54-142
Künt/Blunt



Esnek, şaft/Flexible shaft
Sivri/Sharp
15.5 cm



54-143
3.5 x 4.5 mm



54-144
4.0 x 7.2 mm



54-145
4.0 x 10.0 mm



54-146
4.0 x 4.5 mm⁴



54-147
.0 x 7.5 mm⁴



54-148
.0 x 10.2 mm⁴



Esnek, şaft/Flexible shaf
Künt/Blunt
15.5 cm



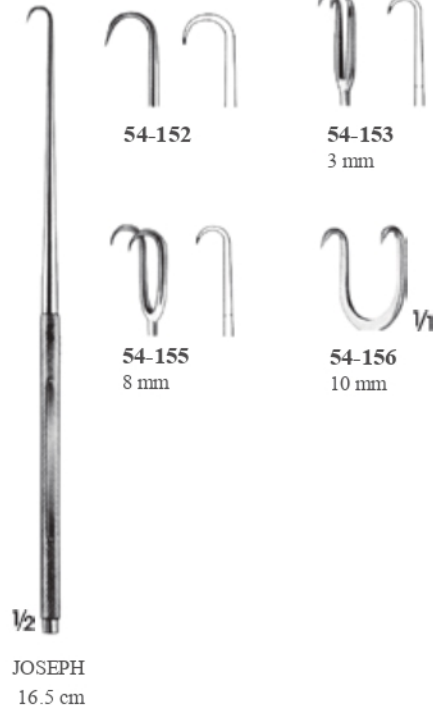
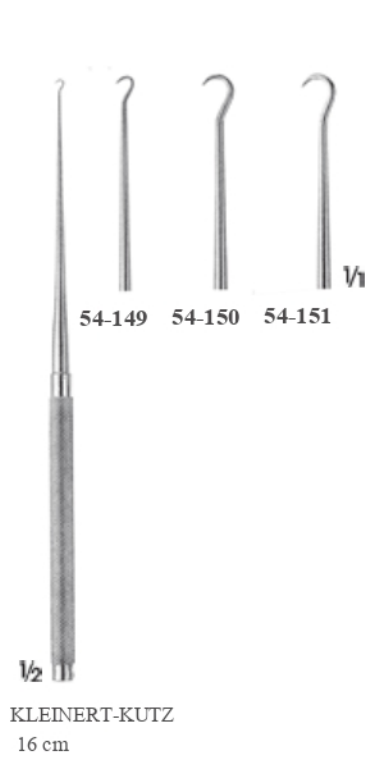



FISCH
54-163
Dura ekartör
Dura retractor
18.5 cm

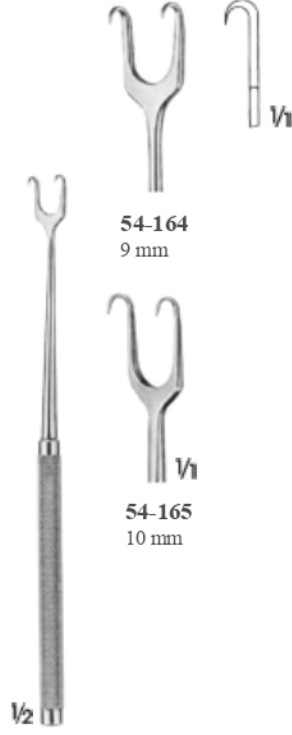

MC INDOE
15 cm

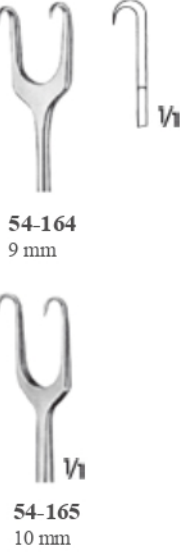

54-164
9 mm

54-165
10 mm



54-166
Ø 1.8 mm
Sterilizasyon koruyucu
Protector for storing and sterilization

Doku piki/Tissue pick
Doku ve deriyi yakalayıp
kaldırmak için çift uçlu
Double picks to grasp and
lift skin, tissue etc
18.5 cm

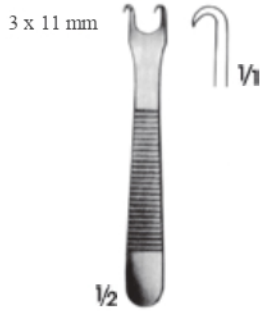

KILNER
54-167
Sivri/Sharp
8 cm

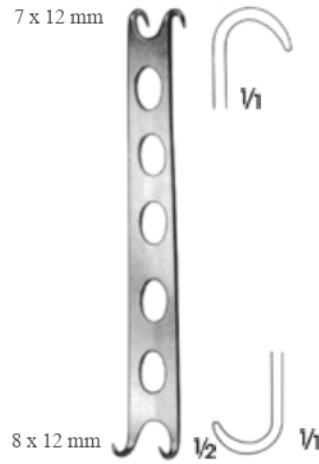

54-168
Künt/Blunt
12 cm



MANNERFELT
54-169
Sivri/Sharp
13.5 cm



MANNERFELT
54-170
Sivri/Sharp
15.5 cm



MANNERFELT
54-171
Sivri/Sharp
15.5 cm



MANNERFELT
54-172
Esnek shaft küçük eğri, sivri
Flexible shaft, small curve, sharp
15.5 cm

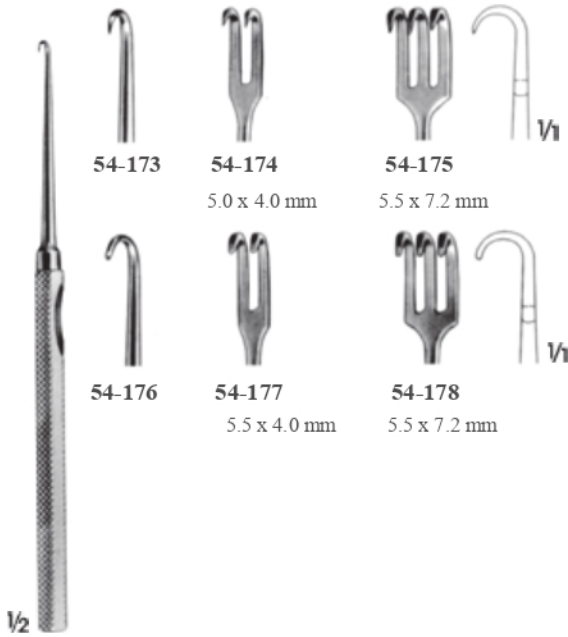

MANNERFELT
54-173 - 54-175 Sivri/Sharp
54-176 - 54-178 Künt/Blunt
Küçük eğri/Small curve
15.5 cm

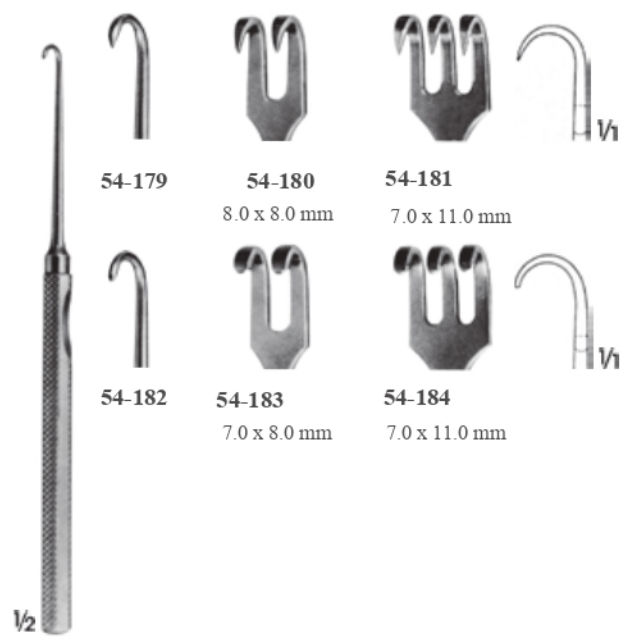

MANNERFELT
54-179 - 54-181 Sivri/Sharp
54-182 - 54-184 Künt/Blunt
Büyük eğri/Large curve
15.5 cm



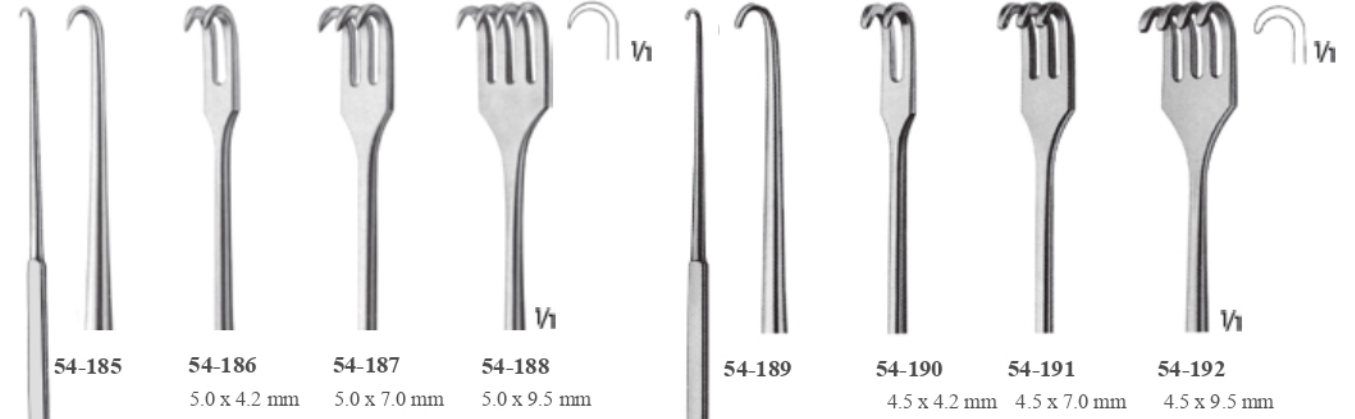

54-185

54-186

54-187

54-188

54-189

54-190

54-191

54-192

5.0 x 4.2 mm

5.0 x 7.0 mm

5.0 x 9.5 mm

4.5 x 4.2 mm

4.5 x 7.0 mm

4.5 x 9.5 mm

1/2

1/2

Sivri/Sharp 16.5 cm
Küçük eğri/Small curve

Künt/Blunt 16.5 cm
Küçük eğri/Small curve

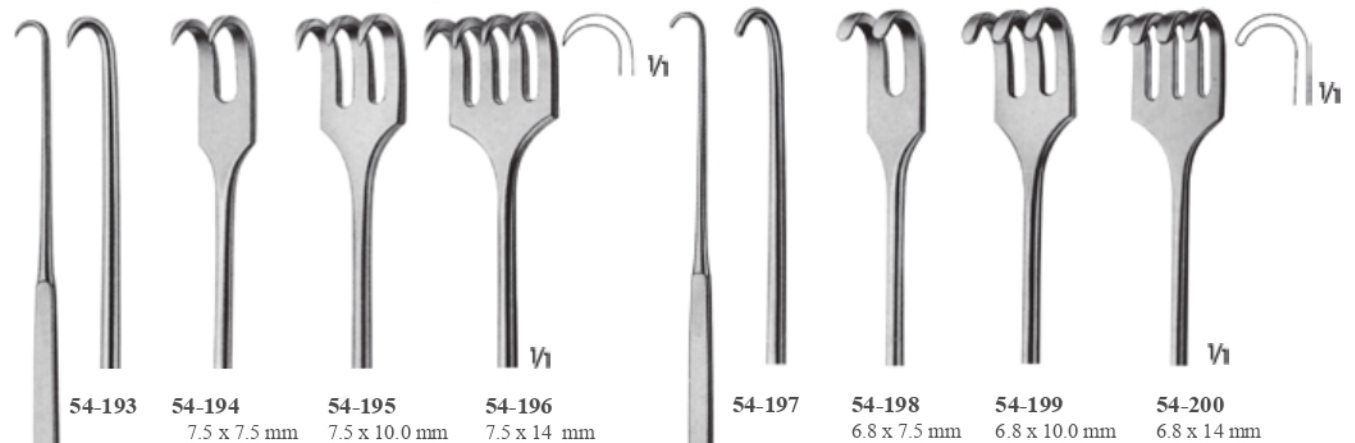

54-193

54-194

54-195

54-196

54-197

54-198

54-199

54-200

7.5 x 7.5 mm

7.5 x 10.0 mm

7.5 x 14 mm

6.8 x 7.5 mm

6.8 x 10.0 mm

6.8 x 14 mm

1/2

1/2

Sivri/Sharp 16.5 cm
Büyük eğri/Large curve

Künt/Blunt 16.5 cm
Büyük eğri/Large curve



$\frac{1}{2}$
FOMON
54-201
Künt/Blunt
14.5 cm



$\frac{1}{2}$
COTILE
54-202
Sağ sivri/Right sharp
14.5 cm



$\frac{1}{2}$
Sivri/Sharp
16 cm



$\frac{1}{2}$
54-205
16 cm



$\frac{1}{2}$
LANGENBECK-GREEN
16 cm



$\frac{1}{2}$
STRANDELL-STILLE

Tendon Hukları/Tendon Hooks
18 cm

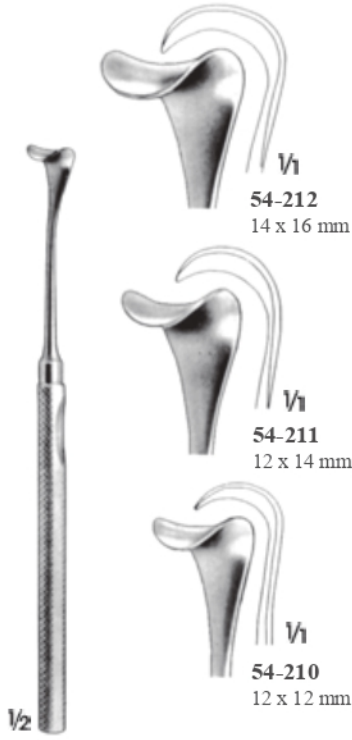

MANNERFELT
Eyer huklar/Saddle
hooks 15.5 cm



MANNERFELT
54-213
Oluklu/Hollow grooved
15.5 cm



LANGENBECK-MANNERFELT
15.5 cm



MANNERFELT
54-218
Eyer huk, çerçevesi
Saddle hook, fenestrated
15.5 cm



MANNERFELT
54-219
Tendon çift uçlu huk
Tendon double hook
16 cm

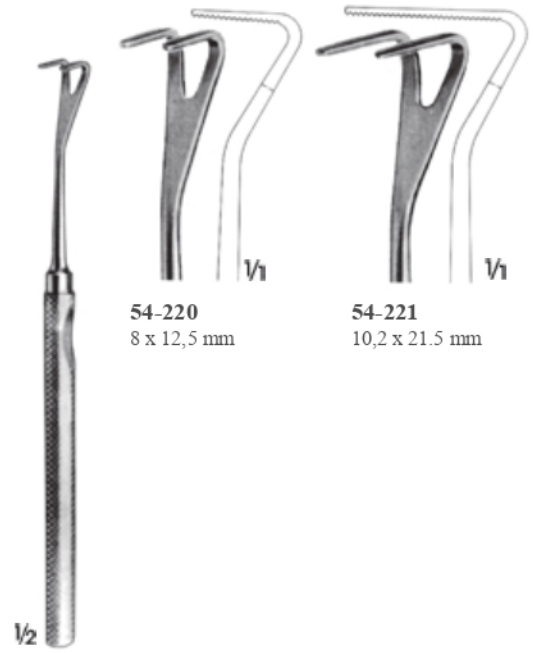

MANNERFELT
Geri eğimli çatallı huk
Forked hooks, retrograded
curved
15.5 cm



54-223
12 x 16 mm



54-222
13 x 13 mm

KÖNIG
18 cm

1/2



54-225
14 x 18 mm



54-224
10 x 13 mm

CUSHING
20.5 cm

1/2



Damar boyunca diseksiyon
Fo longitudinal dissection of
vessels

54-226
Küçük diseksiyon huk
Small dissecting hook
23.5 cm

1/2

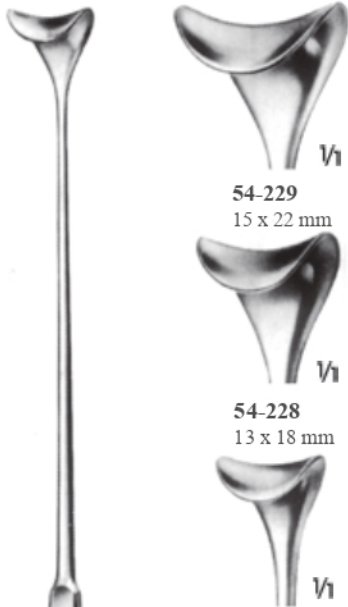

54-229
15 x 22 mm



54-228
13 x 18 mm



54-227
11 x 14 mm

CUSHING
25 cm

1/2



SCHOENBORN
54-230
20 cm

1/2

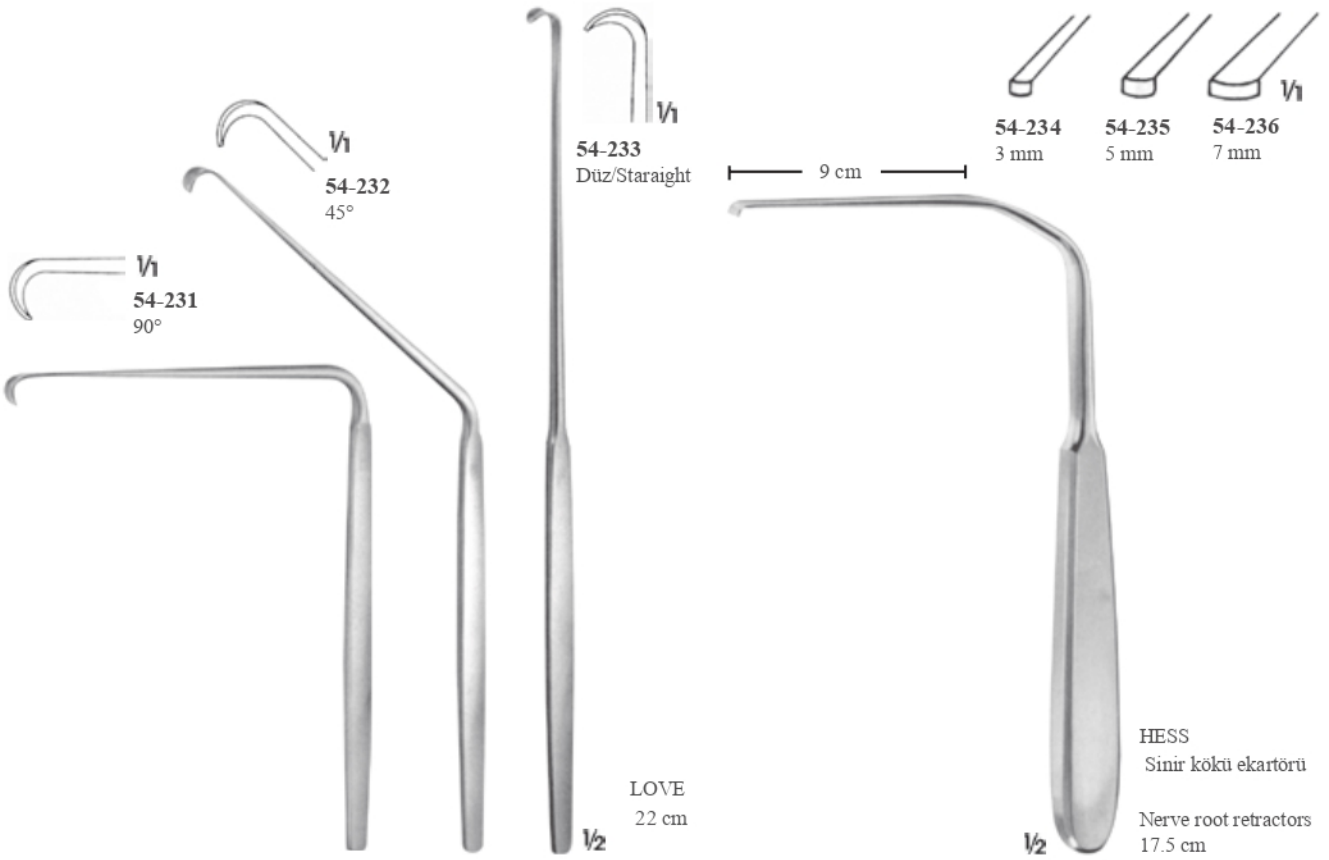

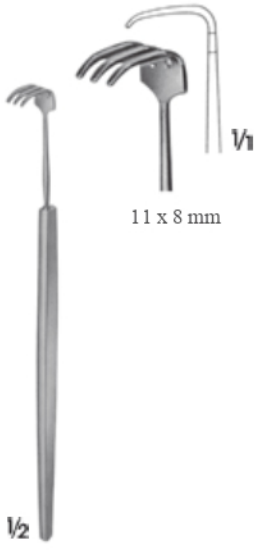

PAUL
54-244
Tendon huk/Tendon hook
12 cm

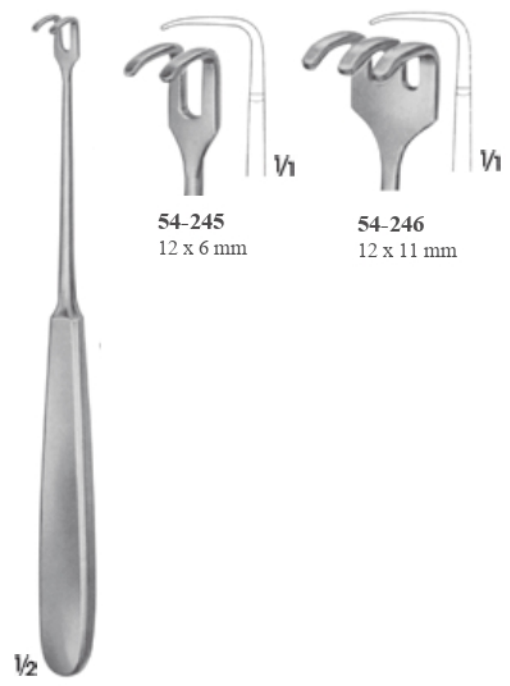

17.5 cm
Tendon hukları/Tendon hooks



KLAPP
54-247
Tendon huk/Tendon hook
17.5 cm

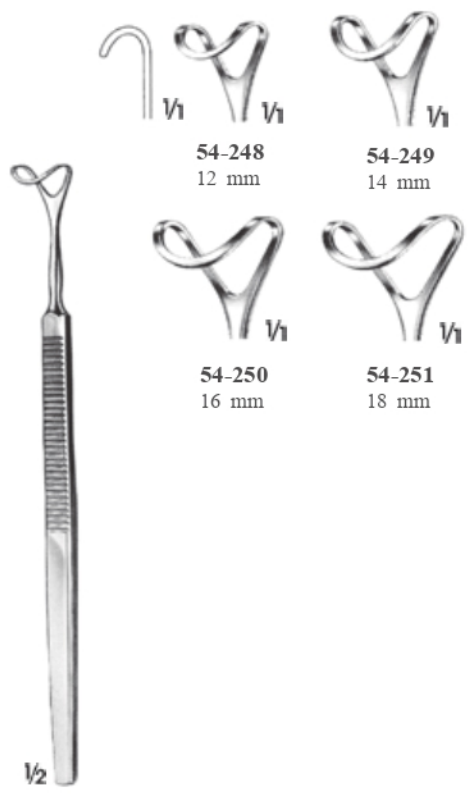

16 cm



KOCHER
20.5 cm

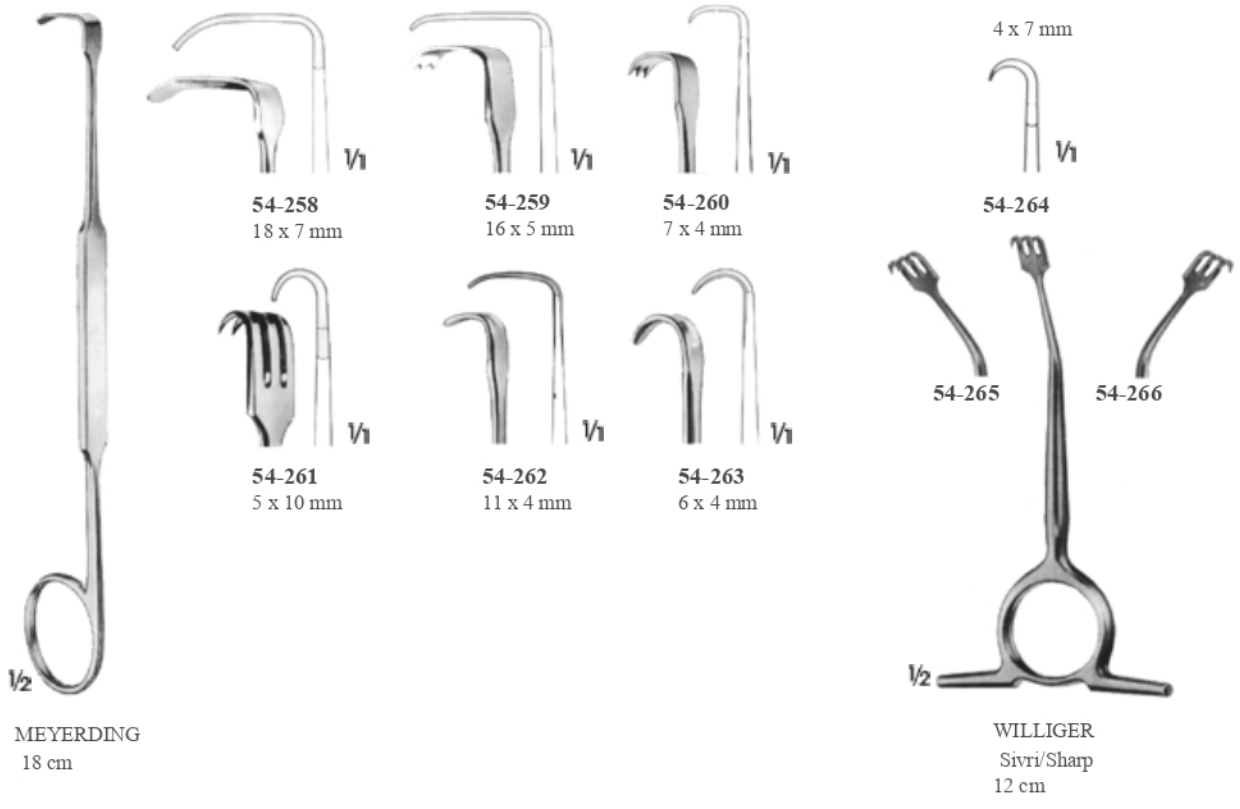
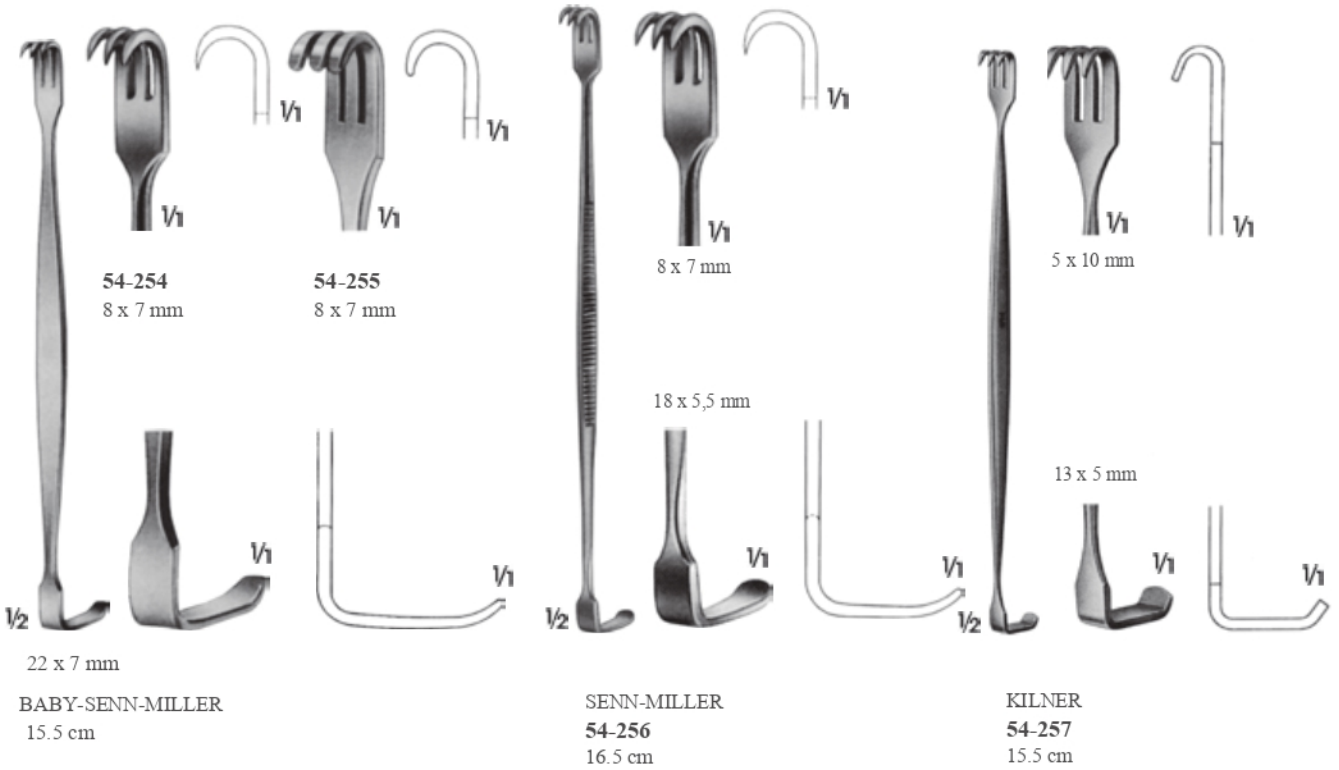



6 x 12 mm

MASING
54-267

Yara ekartör /Wound retractor
14 cm



10 x 12 mm

COTTLE
54-268

Yara ekartör /Wound retractor
14 cm



54-269
9 x 9 mm

54-270
9 x 12 mm

54-271
11 x 14 mm

DESMARRES

Yara ekartörleri /Wound retractors
14 cm

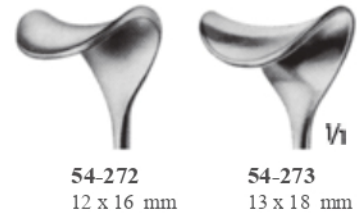

54-272
12 x 16 mm

54-273
13 x 18 mm



SIMON
54-274

Fistül huk/Fistula hook
22 cm



LANGE
54-275

Fistül huk/Fistula hook
23.5 cm





25 x 10 mm
22 x 10 mm



28 x 12 mm
32 x 12 mm

FARABEUF
54-276
12.5 cm

23 x 16 mm
20 x 16 mm



24 x 16 mm
28 x 16 mm

FARABEUF
54-277
15 cm

21 x 14 mm
17 x 14 mm



28 x 16 mm
32 x 16 mm

COLLIN
54-278
15 cm

5 x 3 mm



14 x 6.3 mm
RAGNELL
54-279
15 cm

10 x 8 mm



12 x 11 mm
LUER
54-280
11 cm

11 x 4 mm



19 x 6 mm
CRILE
54-281
11 cm

10 x 12 mm



11 x 15 mm
ROSE
54-282
13 cm



ROUX
54-283
Komple/Complete
16.5 cm

19 x 22 mm



23 x 30 mm
54-284

25 x 26 mm



28 x 38 mm
54-285

28 x 29 mm



33 x 45 mm
54-286

30 x 19 mm



33 x 25 mm
KILNER
54-287
15 cm

35 x 29 mm

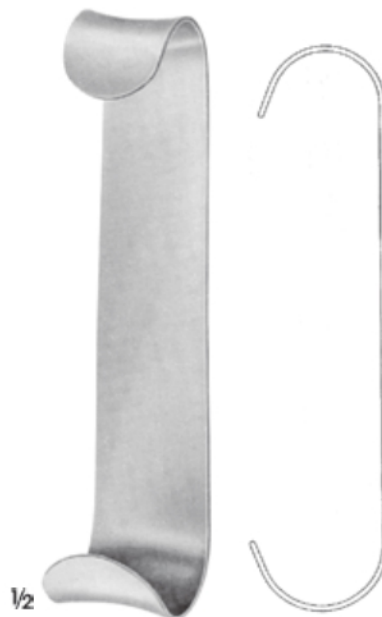

40 x 35 mm
KILNER
54-288
15 cm



GOELET
54-289
19 cm





20 x 22 mm

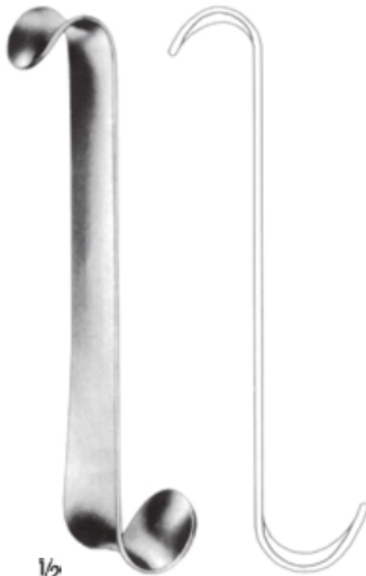

1/2

25 x 29 mm
ROUX
54-290
15 cm

25 x 26 mm

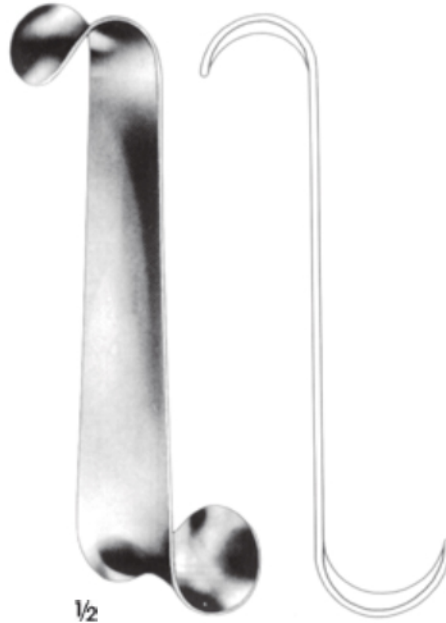

1/2

30 x 38 mm
ROUX
54-291
16 cm

28 x 29 mm

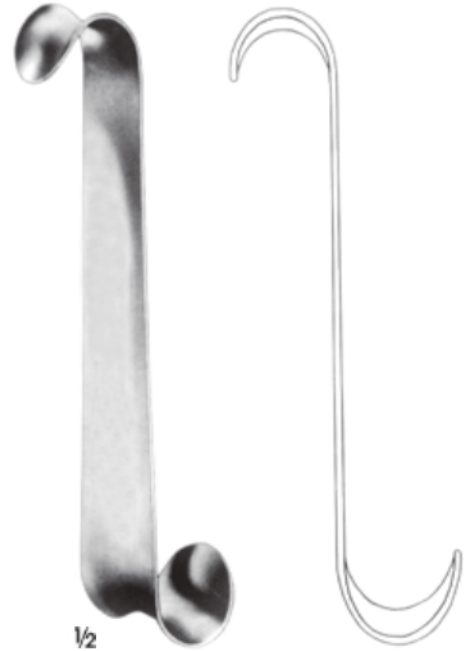

1/2

33 x 44 mm
ROUX
54-292
17 cm

22 x 15 mm
18 x 15 mm



1/2

18 x 15 mm
22 x 15 mm
PARKER
54-293
13.5 cm

17 x 16 mm



1/2

18 x 22 mm
BABY-ROUX
54-294
13.5 cm

36 x 44 mm
30 x 24 mm



1/2

36 x 44 mm
30 x 24 mm
PARKER
54-295
18 cm

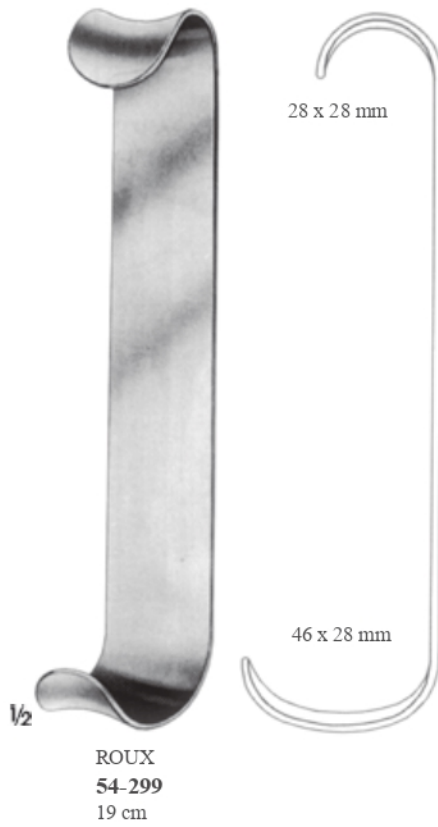
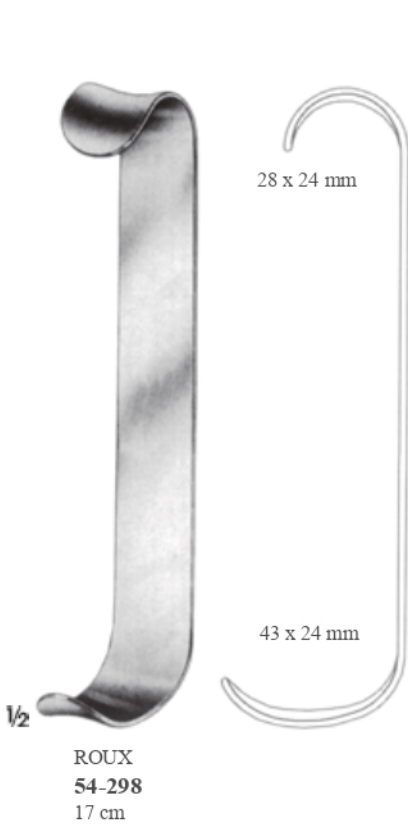
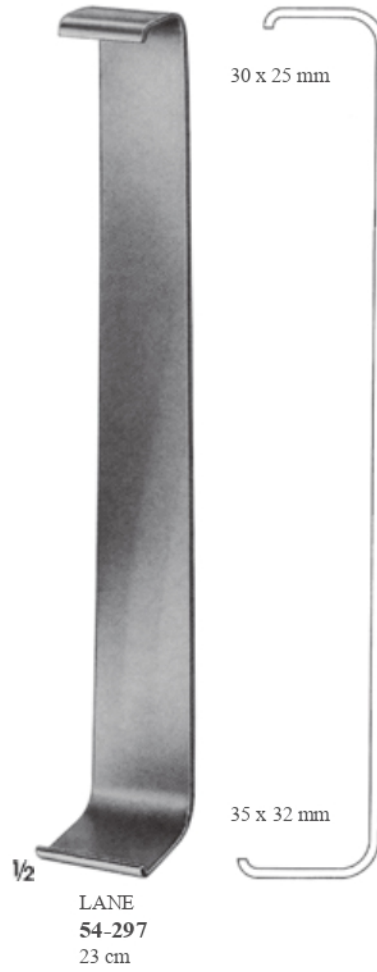
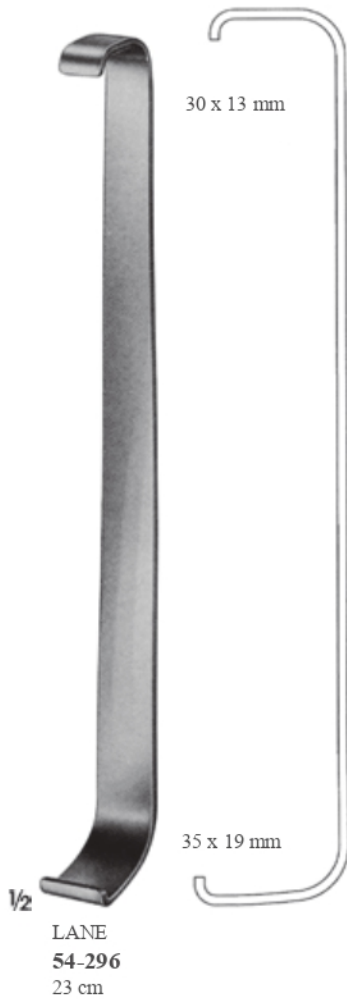



US-ARMY
54-304
22 cm



MATHIEU
54-305
20 cm



CZERNY
54-306
17.5 cm

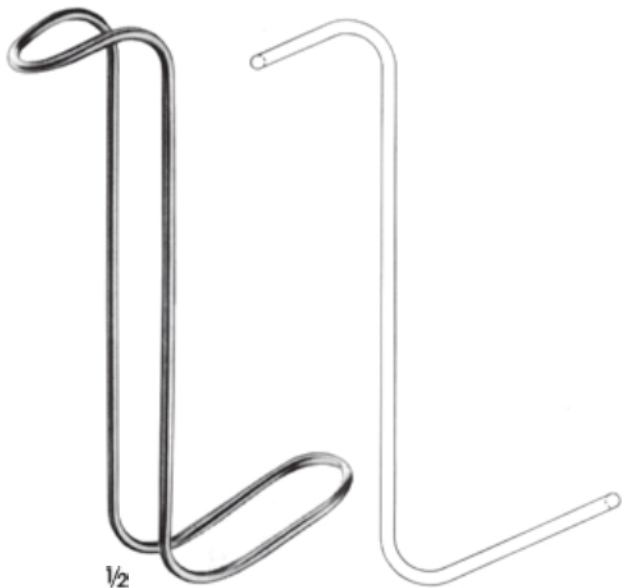

COLLIN-HARTMANN
54-307
15 cm



STERNBERG
54-307 12 cm
54-308 13 cm
54-309 13.5 cm





KOCHER-LANGENBECK
21.5 cm

1/2

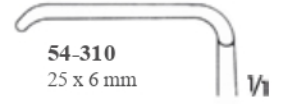

54-310
25 x 6 mm

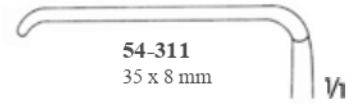

54-311
35 x 8 mm

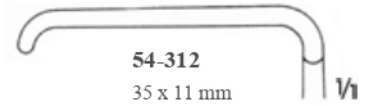

54-312
35 x 11 mm

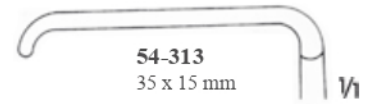

54-313
35 x 15 mm

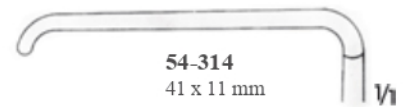

54-314
41 x 11 mm

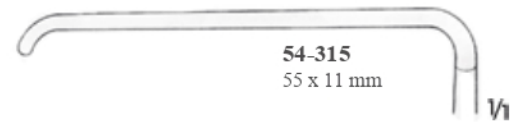

54-315
55 x 11 mm



54-316
70 x 14 mm



54-317
80 x 12 mm



54-318
80 x 16 mm



1/2

LANGENBECK
21 cm

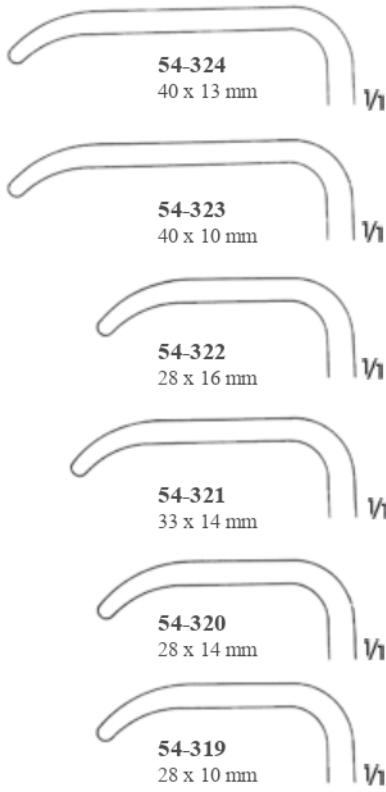

1/2

LANGENBECK
23 cm

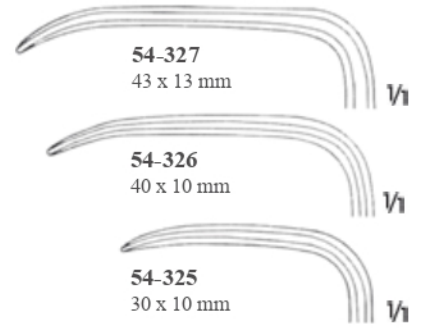

1/2

MURPHY
19.5 cm



54-328
Sivri/Sharp



54-329
Sivri/Sharp



54-330
Künt/Blunt



54-331
Künt/Blunt





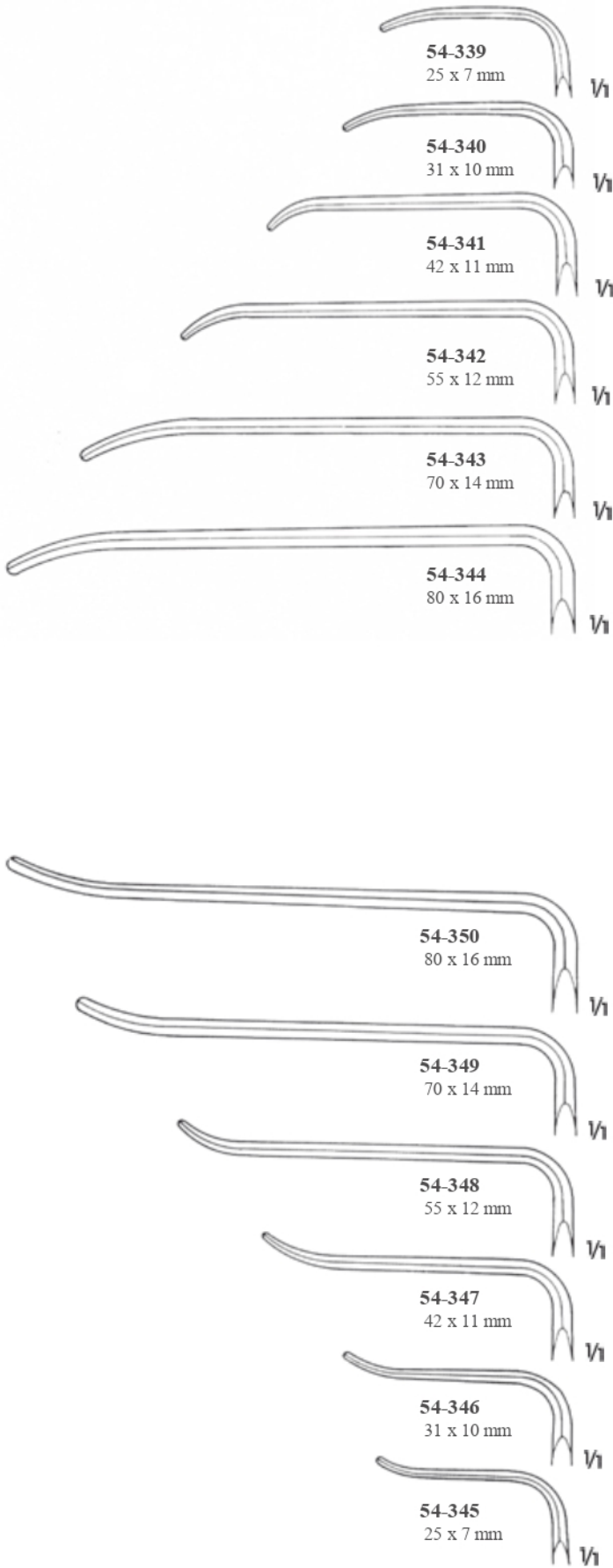

OBWEGESER
21.5 cm



OBWEGESER
21.5 cm

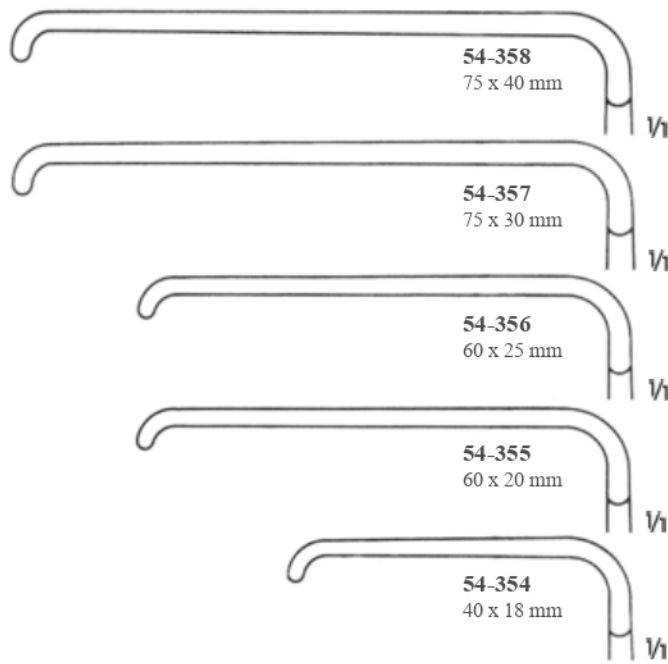
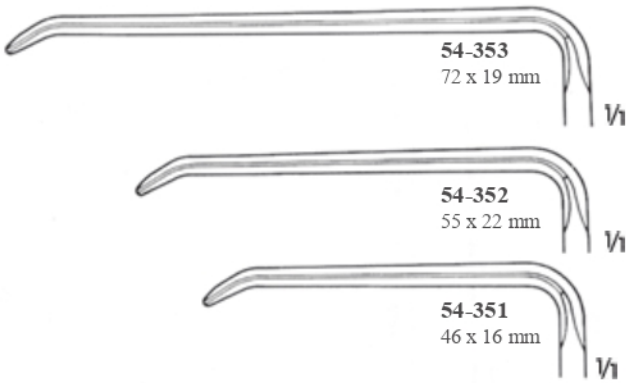



VOLKMANN
22 cm

Sivri
Sharp



54-359
9 x 8 mm



54-360
9 x 13 mm



54-361
9 x 19 mm



54-362
9 x 29 mm



54-363
9 x 40 mm

Künt
Blunt



54-364
8 x 8 mm



54-365
8 x 13 mm



54-366
8 x 19 mm



54-367
8 x 29 mm

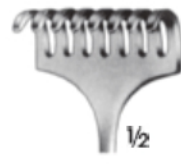

54-368
8 x 40 mm

Yarı sivri
Semi-sharp



54-369
8.5 x 8 mm



54-370
8.5 x 13 mm



54-371
8.5 x 19 mm



54-372
8.5 x 29 mm



54-373
8.5 x 40 mm



VOLKMANN
22.5 cm

Sivri
Sharp



54-374
9 x 8 mm



54-375
9 x 13 mm



54-376
9 x 19 mm



54-377
9 x 29 mm

Künt
Blunt



54-378
8.5 x 8 mm



54-379
8.5 x 13 mm



54-380
8.5 x 19 mm



54-381
8.5 x 29 mm



KOCHER
22 cm

1/2



Yarı sivri
Semi-sharp

1/1



54-382
16 x 9 mm



54-383
16 x 14 mm



54-384
16 x 20 mm



54-385
16 x 30 mm

1/2

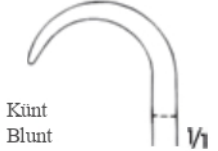

Künt
Blunt

1/1



54-386
15.5 x 9 mm



54-387
15.5 x 14 mm



54-388
15.5 x 20 mm



54-389
15.5 x 30 mm

1/2



26 x 40 mm

1/1



54-390
8 dişli, yarı sivri
8 prongs, semi-sharp

1/2



26 x 40 mm

1/2

54-391
8 dişli, künt
8 prongs, blunt

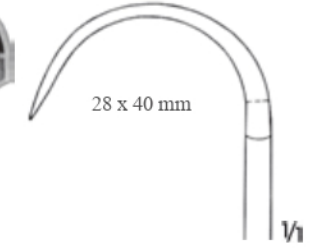

28 x 40 mm

1/1

KÖRTE

Dikey saplı bleyd
Handle vertical to the blade
24 cm

1/2

KÖRTE-WAGNER

54-392
8 dişli, yarı sivri
8 prongs, semi sharp
28 cm

1/2



OLLIER
54-393
4 dişli, künt
4 prongs, blunt
23 cm

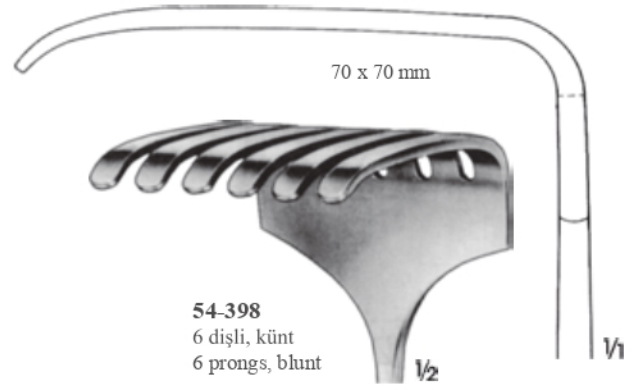

54-398
6 dişli, künt
6 prongs, blunt

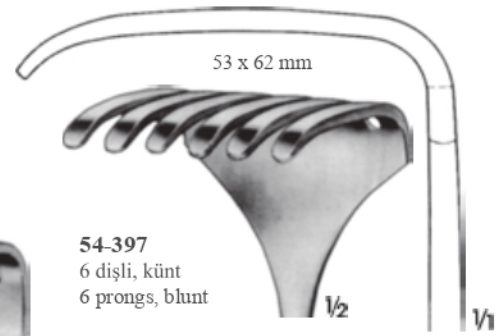

54-397
6 dişli, künt
6 prongs, blunt



KÖRTE
54-394
4 dişli, künt/4 prongs, blunt
Dikey saplı bleyd
Handle vertical to the blade
23 cm

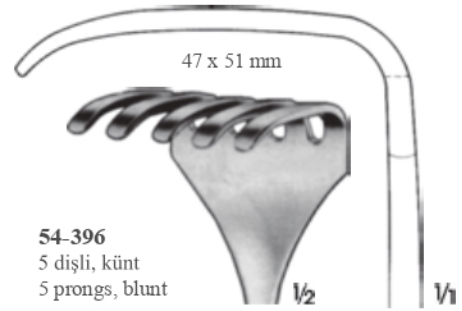

54-396
5 dişli, künt
5 prongs, blunt

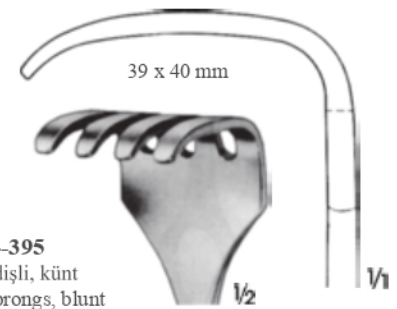

54-395
4 dişli, künt
4 prongs, blunt



ISRAEL
25.5 cm



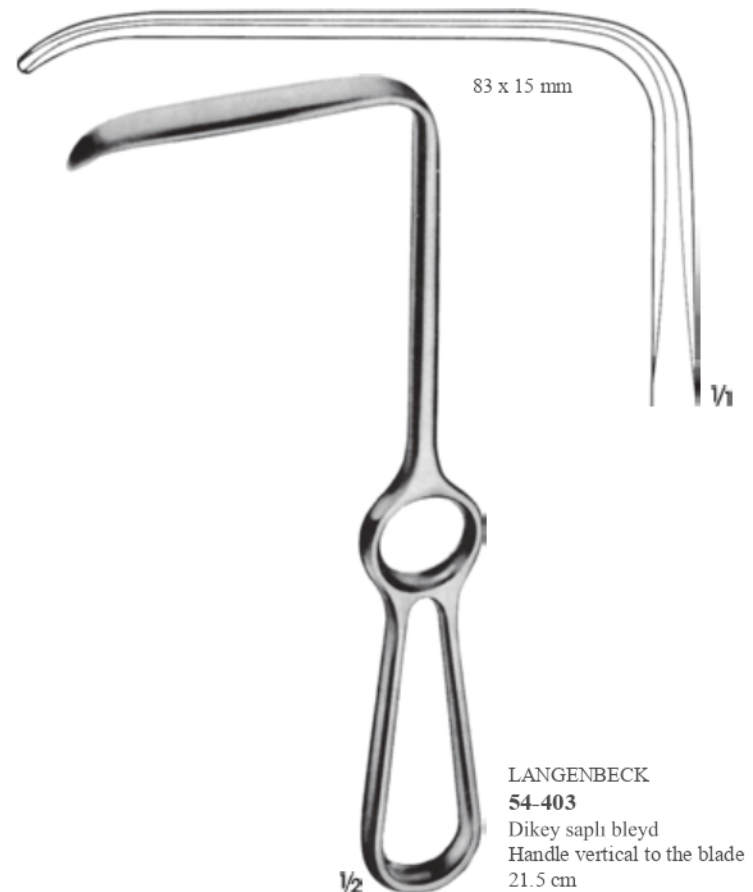
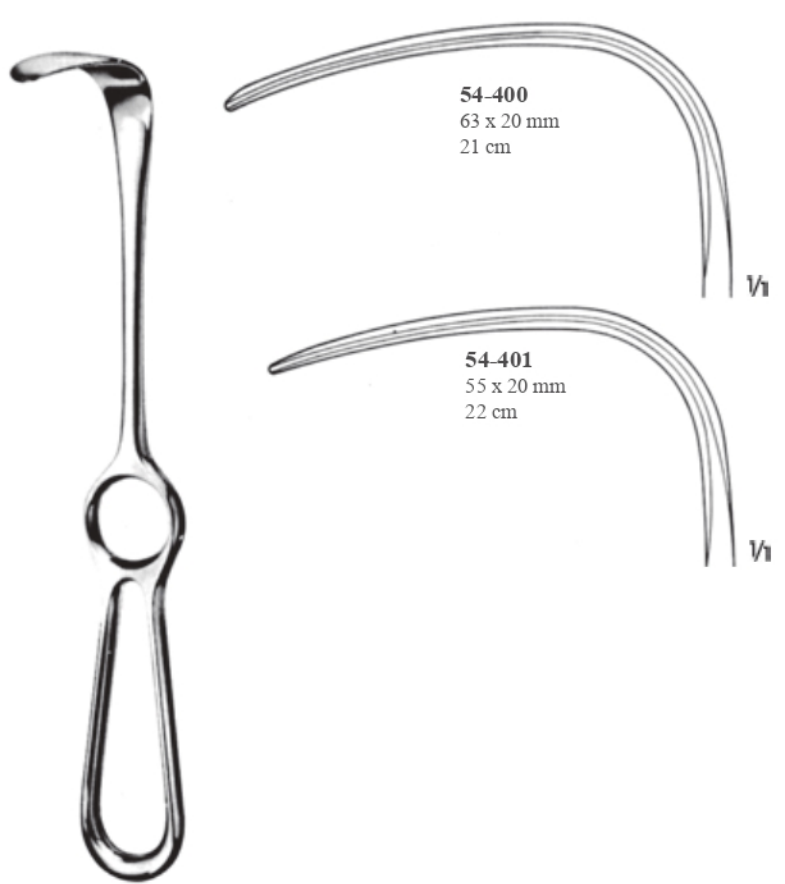

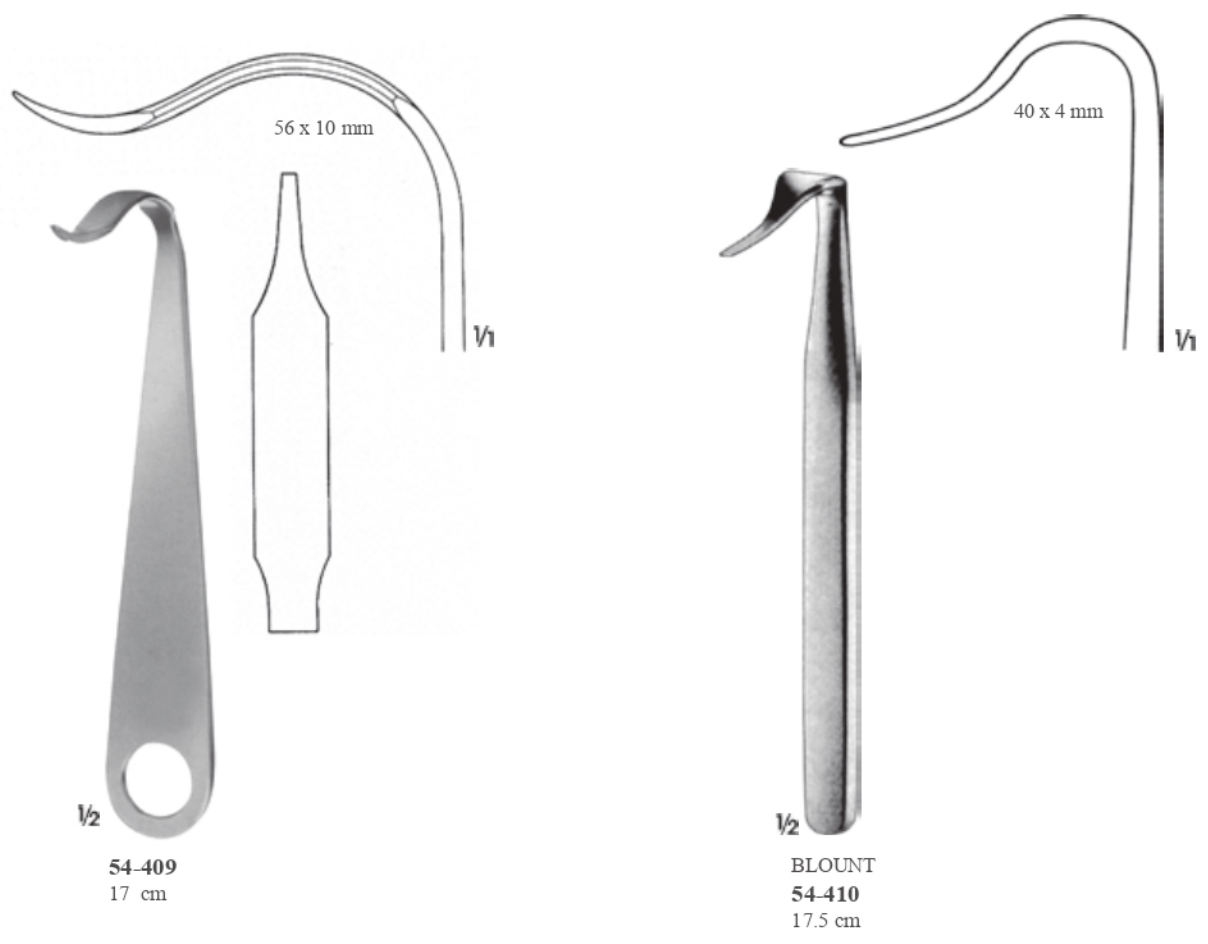
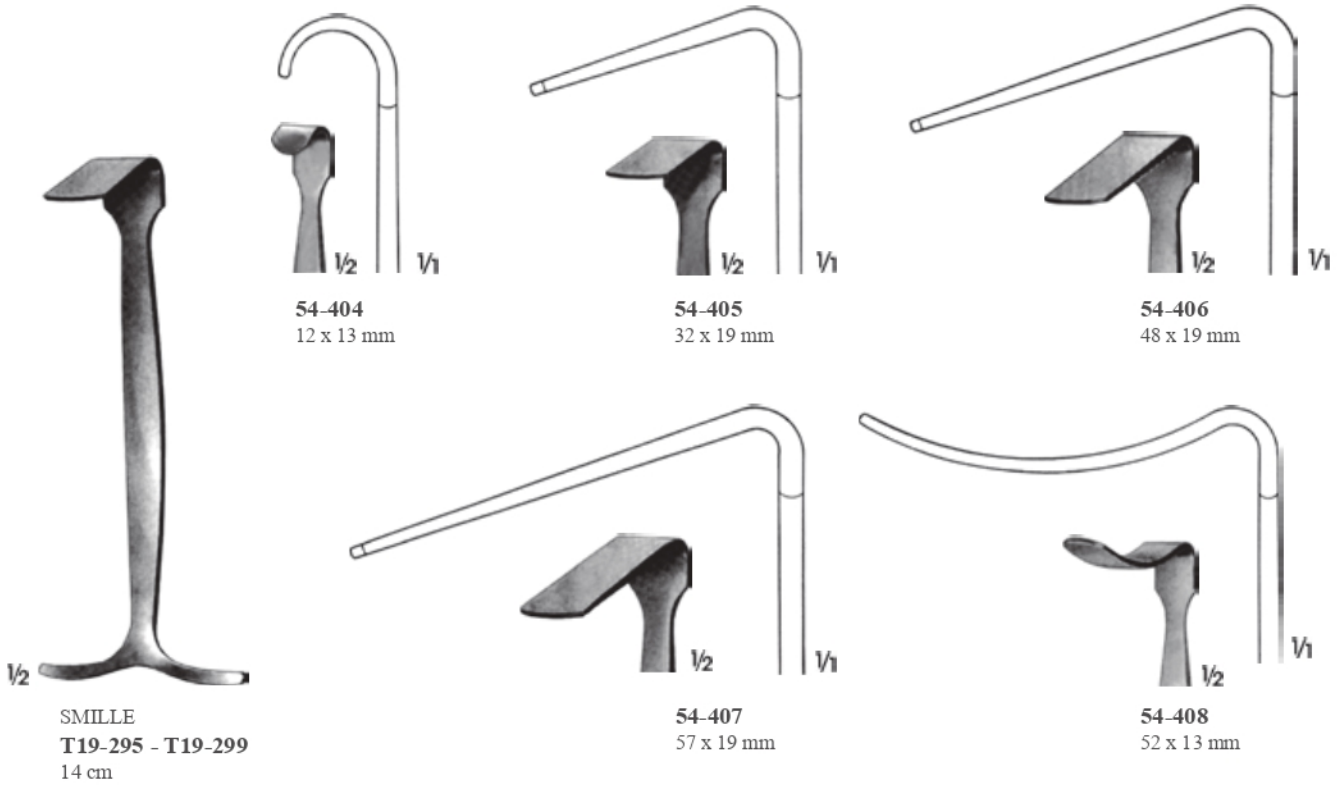



54-411
53 x 15 mm
22.5 cm

54-412
59 x 20 mm
21.5 cm

SCHULZ

Emiş tertibatlı ekartör, ufak ameliyatlarda ve tek elle kullanılır.
Retractor with suction device, for one-handed operation in minor surgery.

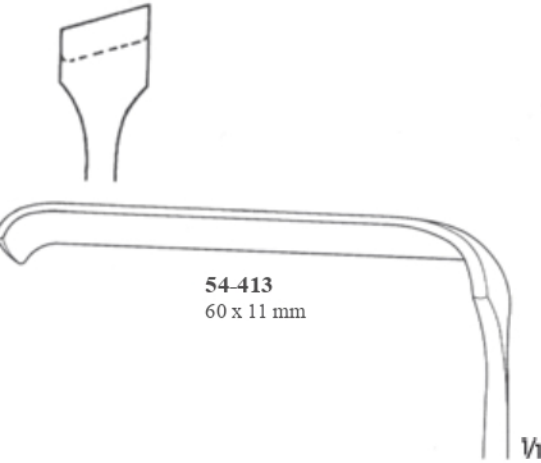

54-413
60 x 11 mm



KIRSCH
21 cm

1/2

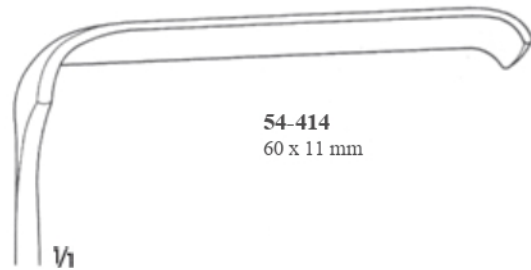

54-414
60 x 11 mm

1/1



MIDDELDORPF



54-415
15 x 15 mm
22 cm

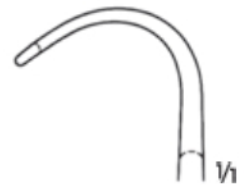

54-416
20 x 22 mm
21.5 cm

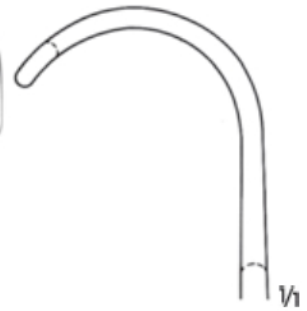

54-417
28 x 28 mm
23.5 cm



1/2

GREENE
54-418
22.5 cm



22 x 22 mm

1/2



1/2

DURHAM
54-419
21.5 cm



16 x 25 mm

1/2





1/2
54-420
20.5 cm



18 x 35 mm



1/1
24 x 8 mm



38 x 9 mm

1/2
LAHEY
54-421
20 cm

1/2
54-422
22.5 cm



BÜCHS
54-423
20.5 cm

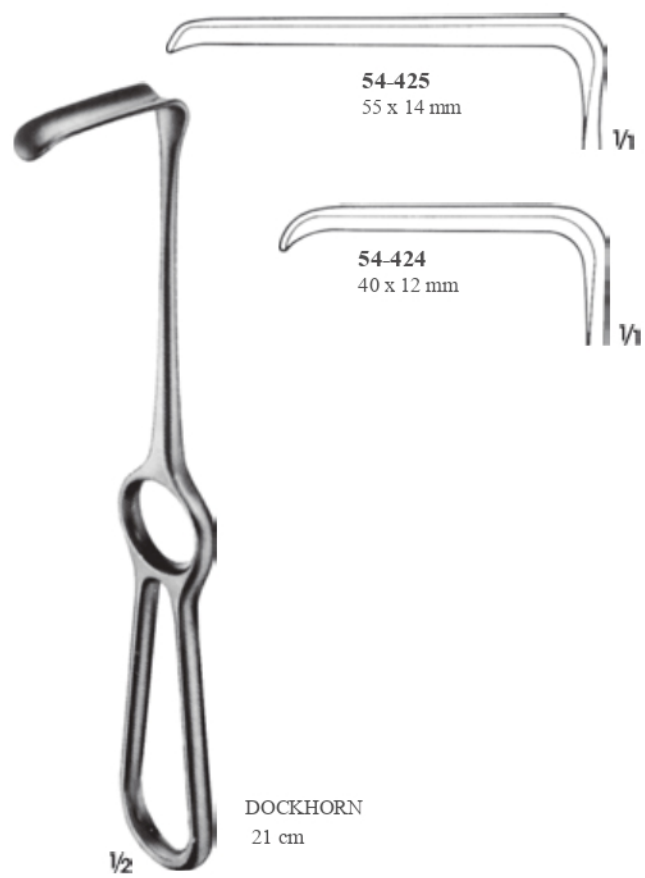

DOCKHORN
21 cm



CASPAR
54-426
21 cm



KRAMER
54-427
21 cm

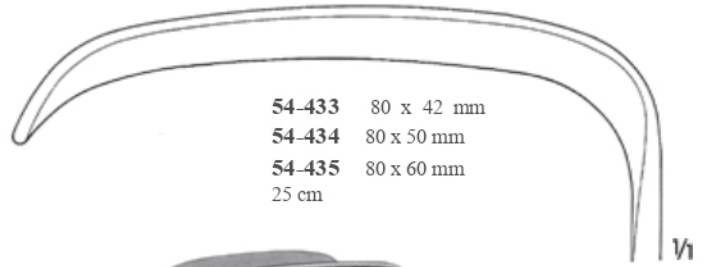
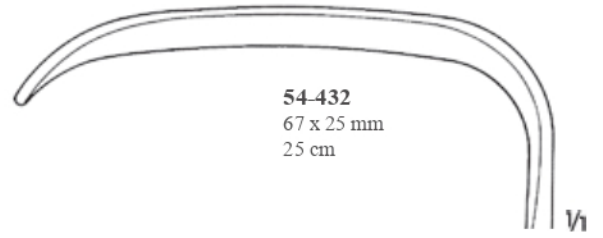
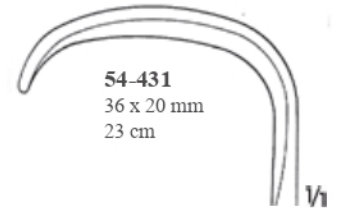
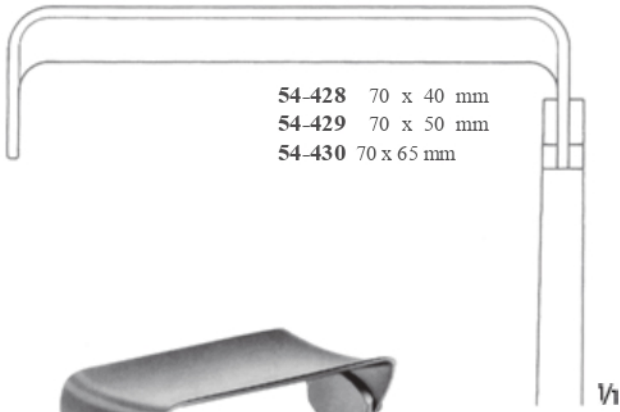

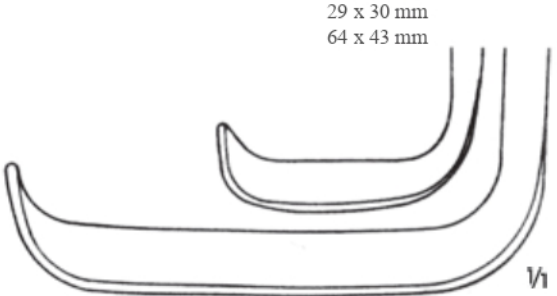
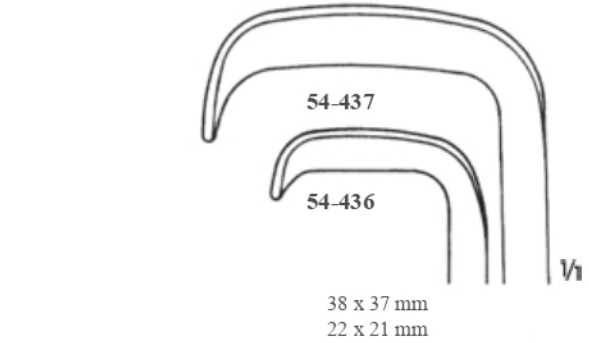

RICHARDSON
54-438
25 cm

V₂



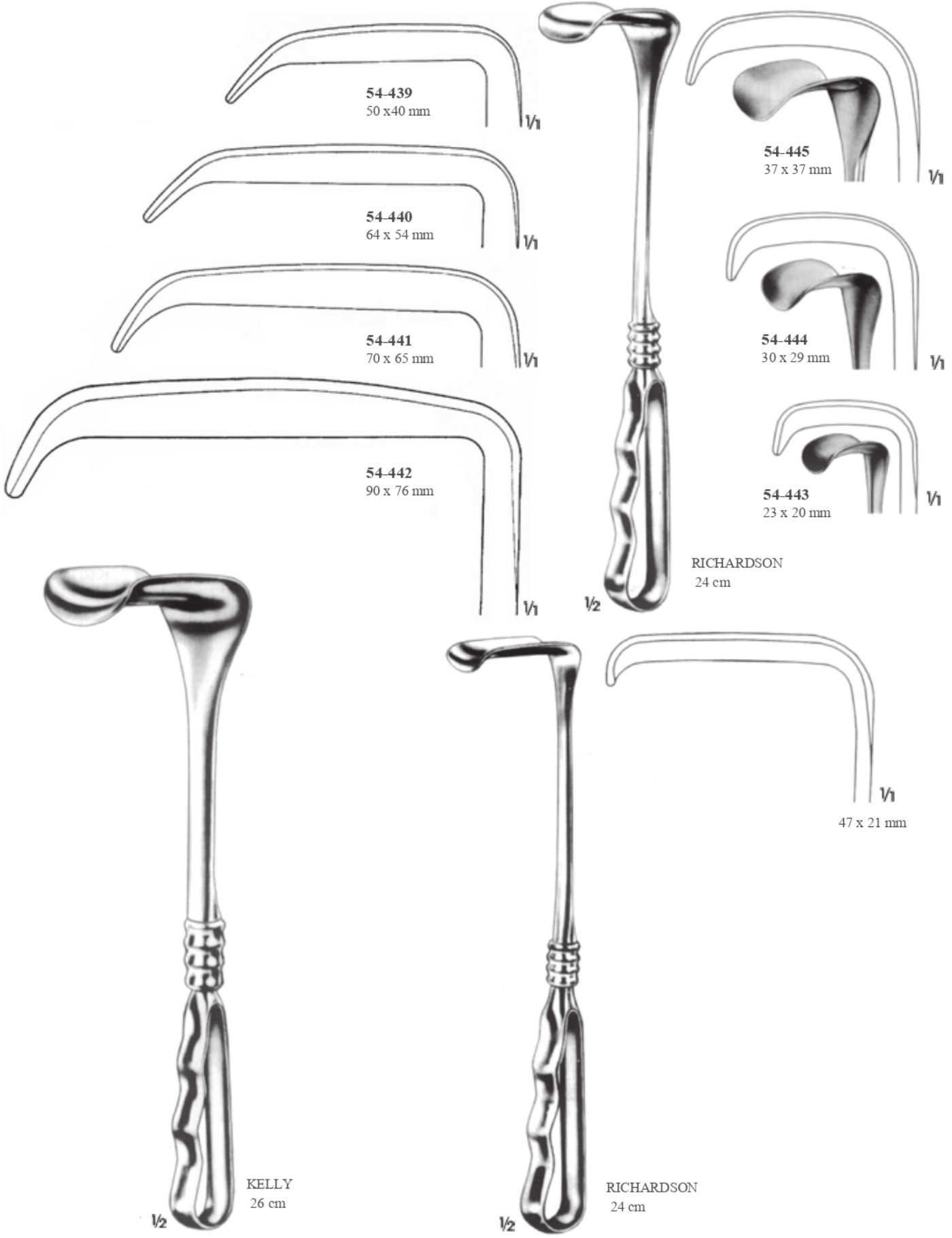

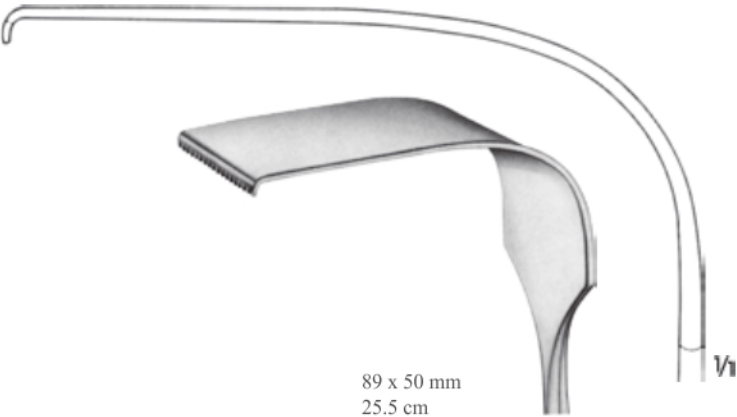

89 x 50 mm
25.5 cm

54-448



76 x 25 mm
23 cm

54-447



52 x 16 mm
23 cm

54-446



MEYERDING



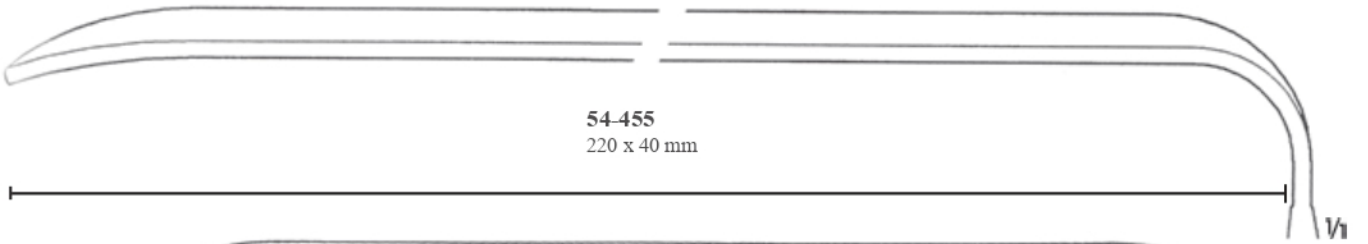

54-455
220 x 40 mm

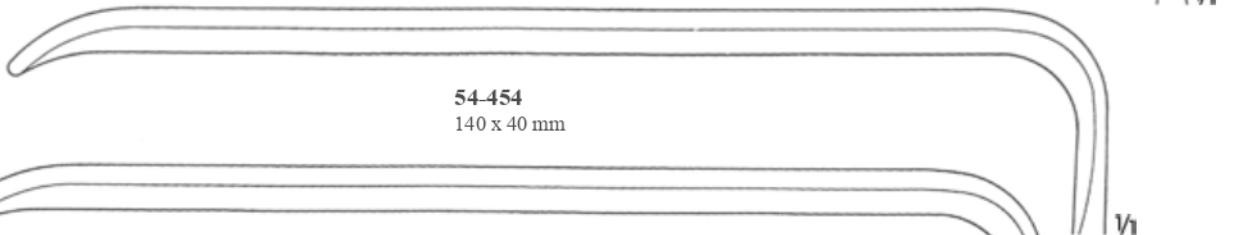

54-454
140 x 40 mm

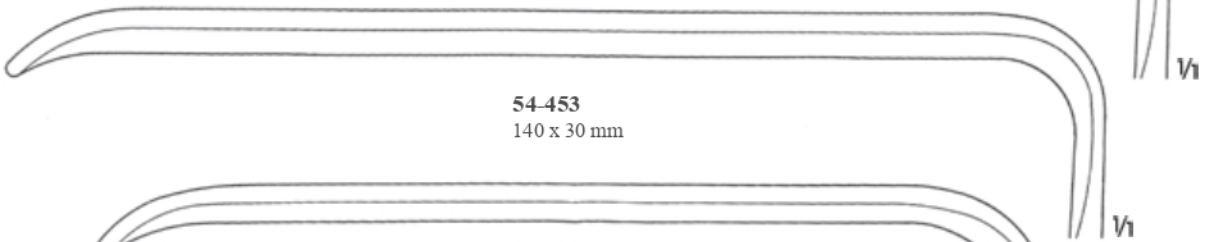

54-453
140 x 30 mm

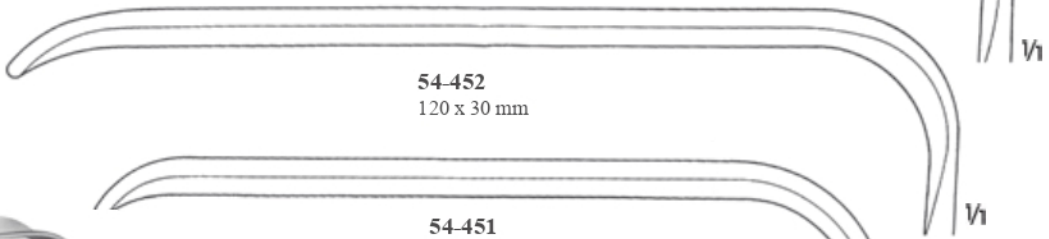

54-452
120 x 30 mm

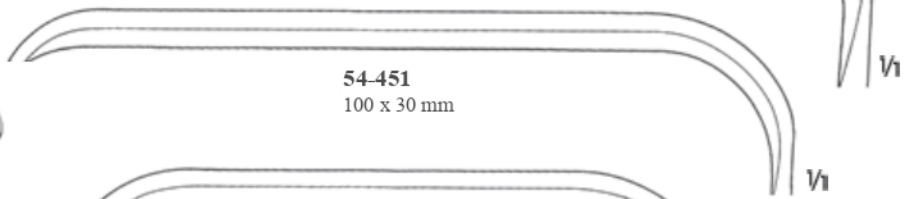

54-451
100 x 30 mm

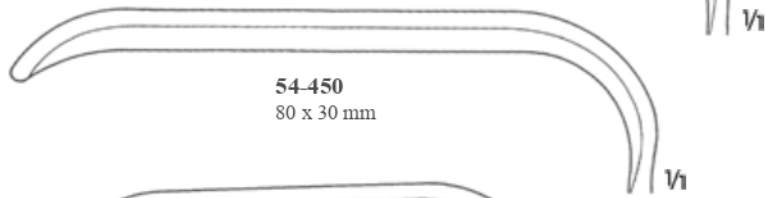

54-450
80 x 30 mm

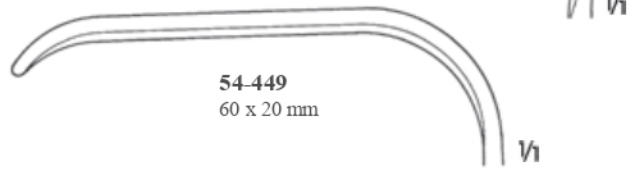

54-449
60 x 20 mm



HÖSEL
25 cm



54-463
94 x 36 mm

54-462
64 x 25 mm

54-461
36 x 20 mm

54-460
20 x 15 mm

$\frac{1}{2}$
KOCHER-WAGNER
28 cm



$\frac{1}{2}$
ZENKER
54-464
24 cm

$\frac{1}{2}$
ZENKER
54-465
25.5 cm

$\frac{1}{2}$
ZENKER
54-466
27 cm

$\frac{1}{2}$
ZENKER
54-467
29 cm

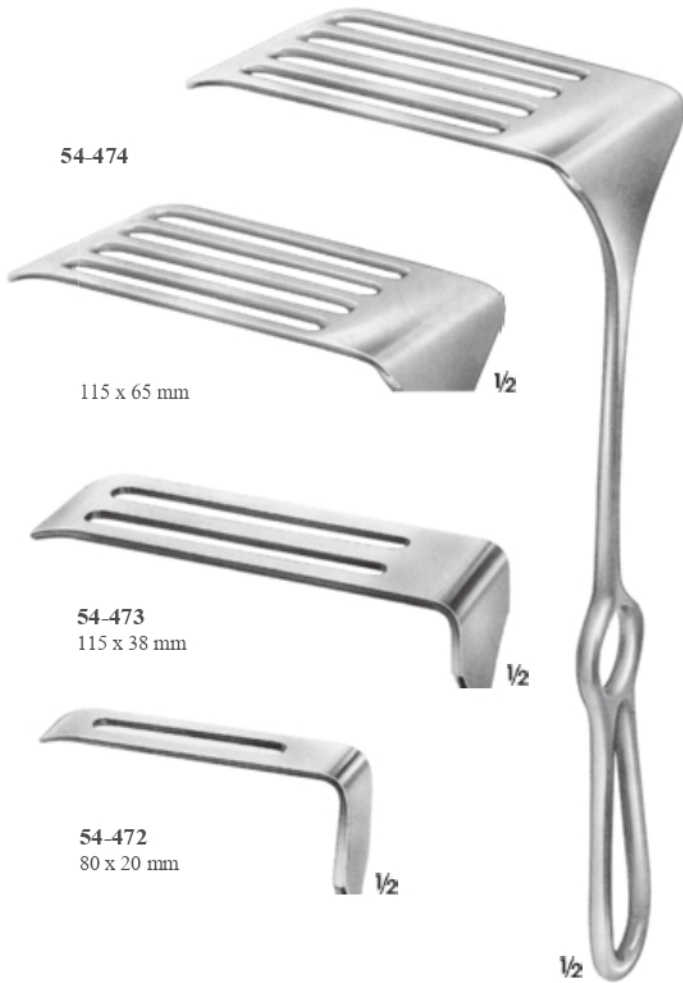
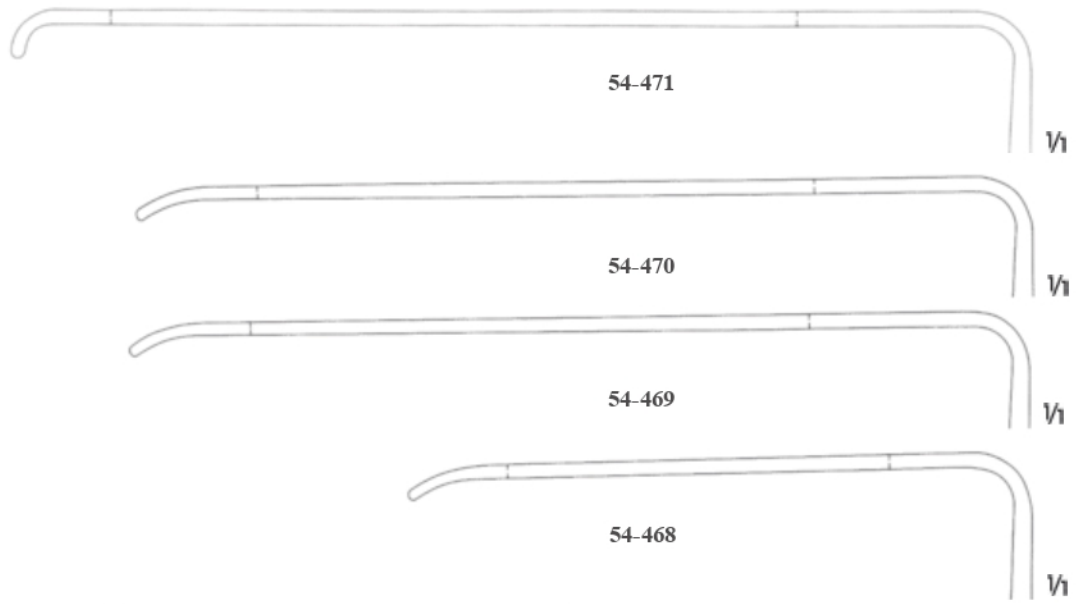

54-474

115 x 65 mm

54-473

115 x 38 mm

54-472

80 x 20 mm

54-471

54-470

54-469

54-468

130 x 38 mm

CORYLLOS
25.5 cm

SAUERBRUCH
26 cm

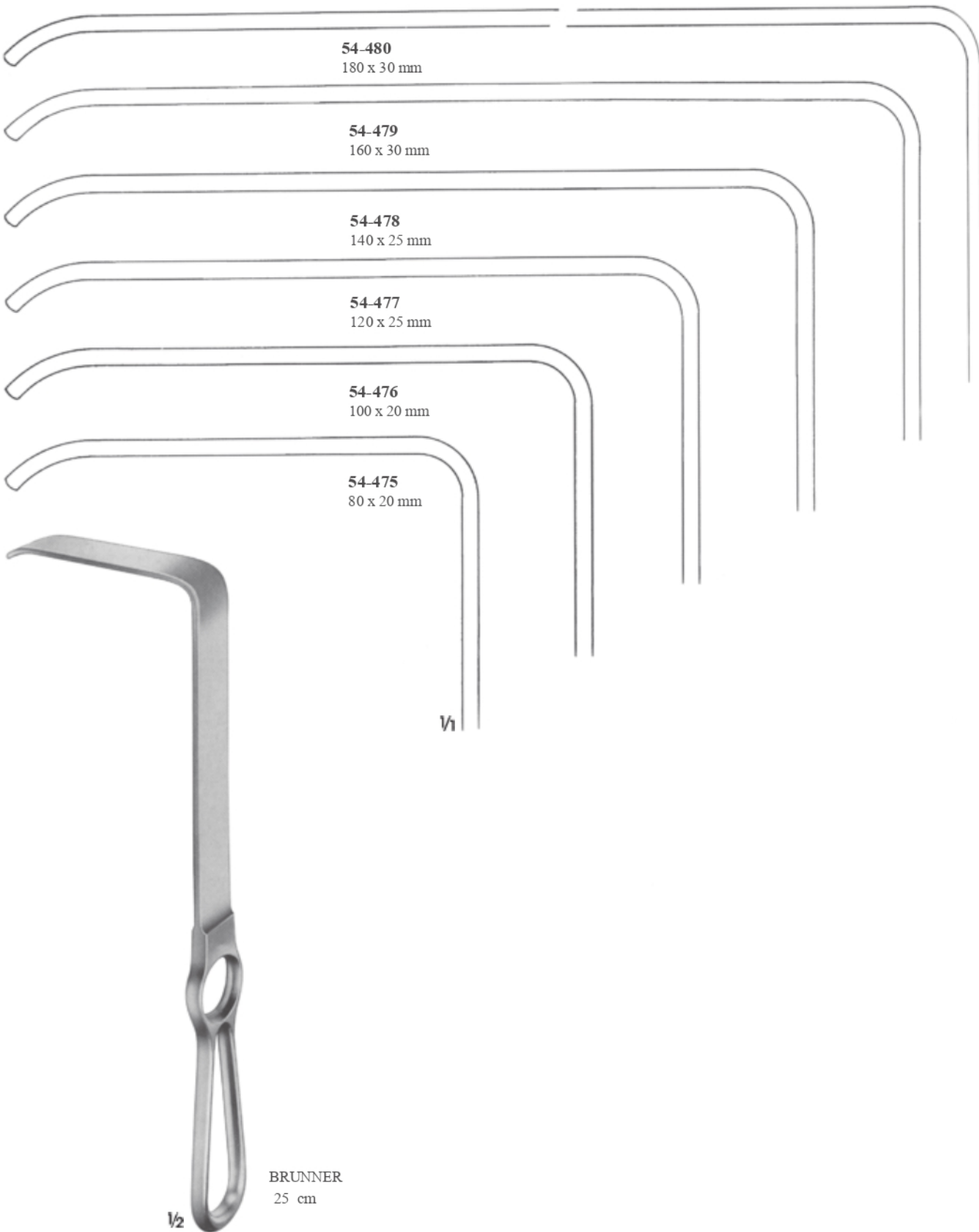

54-480
180 x 30 mm

54-479
160 x 30 mm

54-478
140 x 25 mm

54-477
120 x 25 mm

54-476
100 x 20 mm

54-475
80 x 20 mm

BRUNNER
25 cm

1/2

1/1



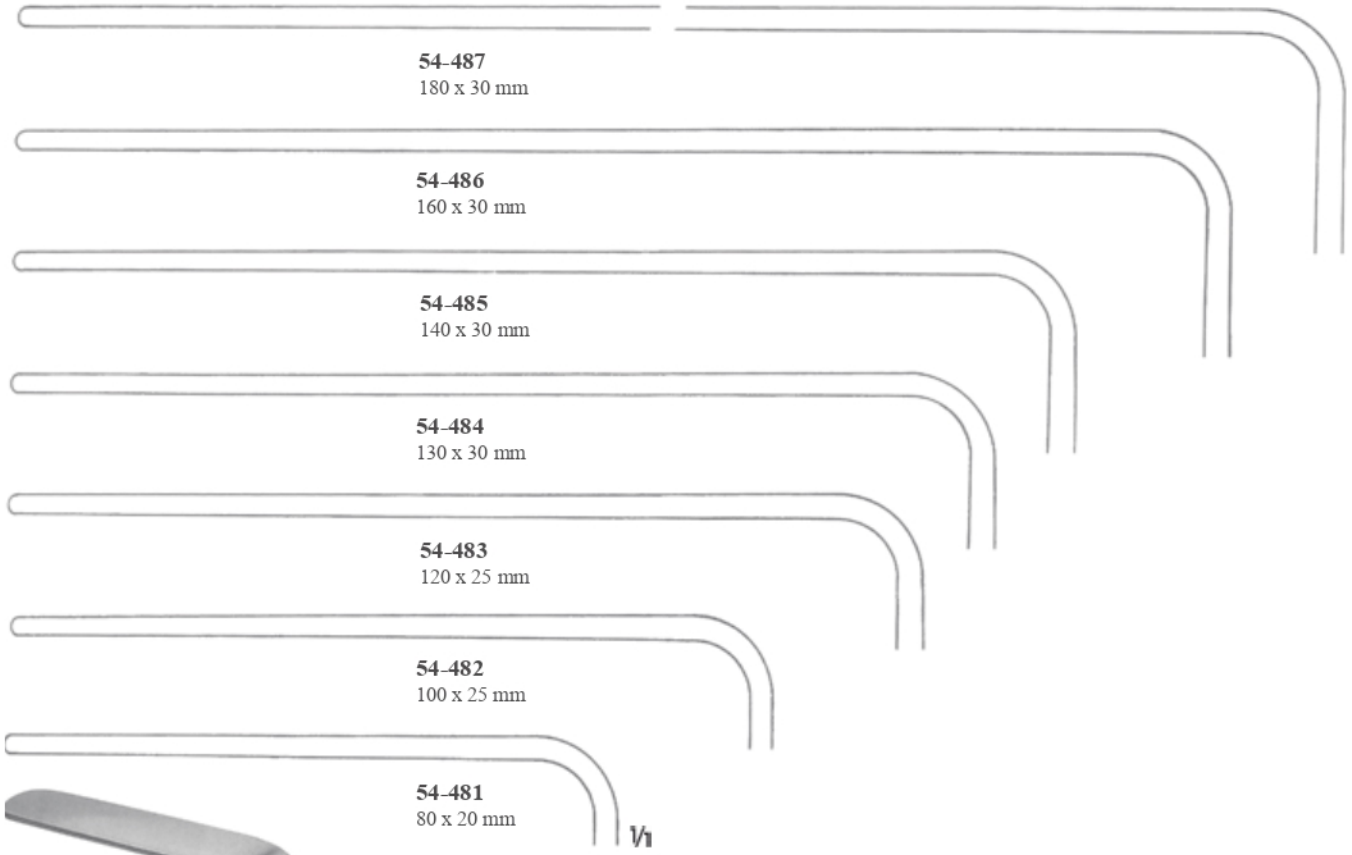
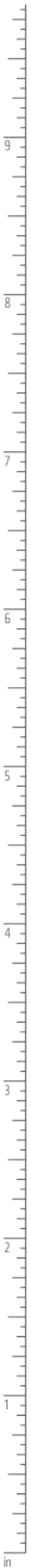

54-487
180 x 30 mm

54-486
160 x 30 mm

54-485
140 x 30 mm

54-484
130 x 30 mm

54-483
120 x 25 mm

54-482
100 x 25 mm

54-481
80 x 20 mm

1/2



BRUNNER
27.5 cm

1/2



DEAVER
54-488
30 cm



DEAVER
54-489
31.5 cm



75 mm

1/2

DEAVER
54-490
32 cm



25 mm

1/2

DEAVER
54-491
36.5 cm



38 mm

1/2

DEAVER
54-492
30 cm



50 mm

1/2

DEAVER
54-493
31 cm







LERICHE
54-496
25.5 cm



LERICHE
54-497
27.5 cm





50 mm

1/2

DEAVER
54-498
30.5 cm



75 mm

1/2

DEAVER
54-499
31 cm



1/2

54-500
Üretral ekartör
Urethral retractor
39 cm



1/2

54-501
Prostat ekartör
Prostate retractor
36 cm



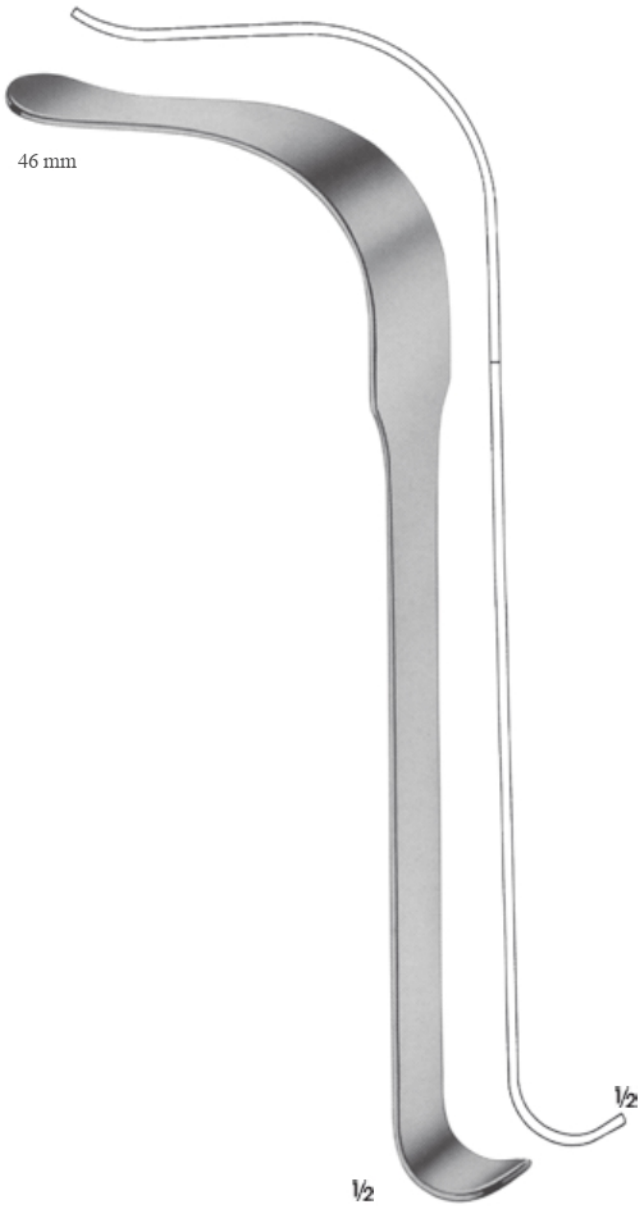

KÖRTE
54-502
30 cm



KÜMMEL
54-503
Bükülebilir/Malleable
28.5 cm

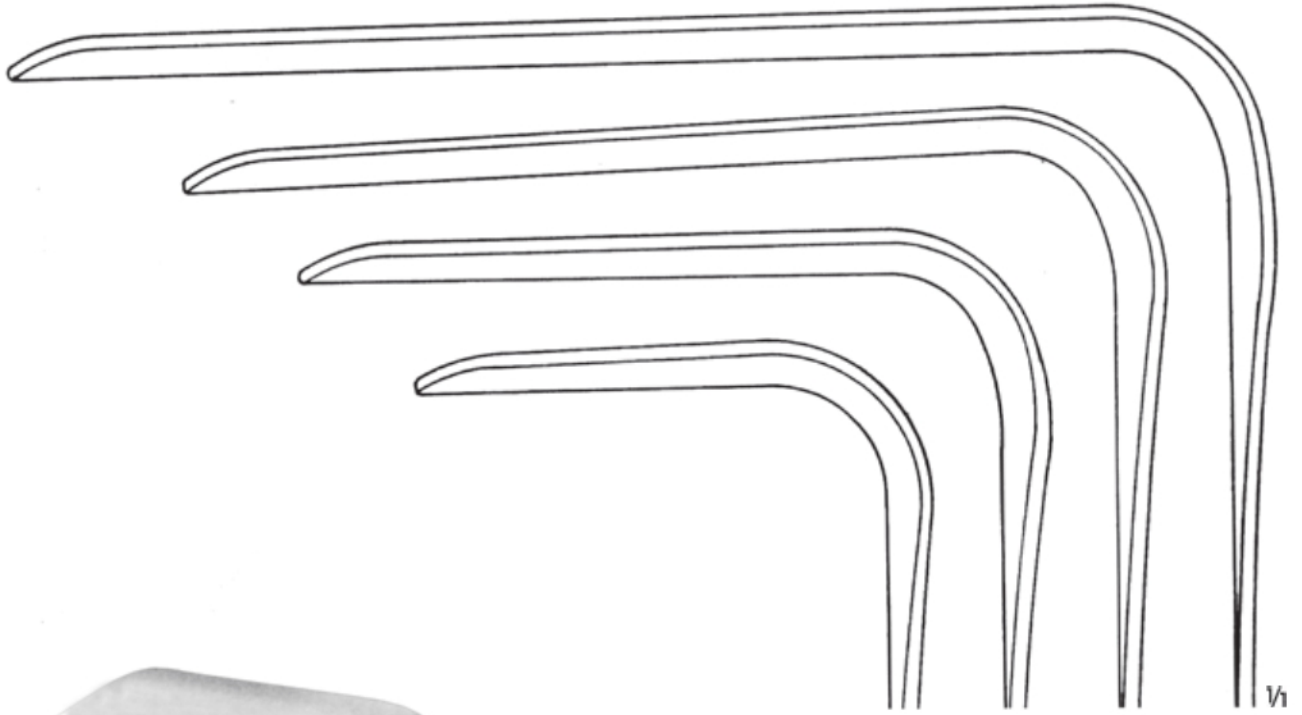

DOYEN
24 cm

Ağız uzunlukları
Length of blades

Ağız genişlikleri
Width of blades

60 mm	35 mm	45 mm	60 mm
	54-504	54-507	54-511
90 mm	54-505	54-508	54-512
120 mm	54-506	54-509	54-513
160 mm		54-510	54-514

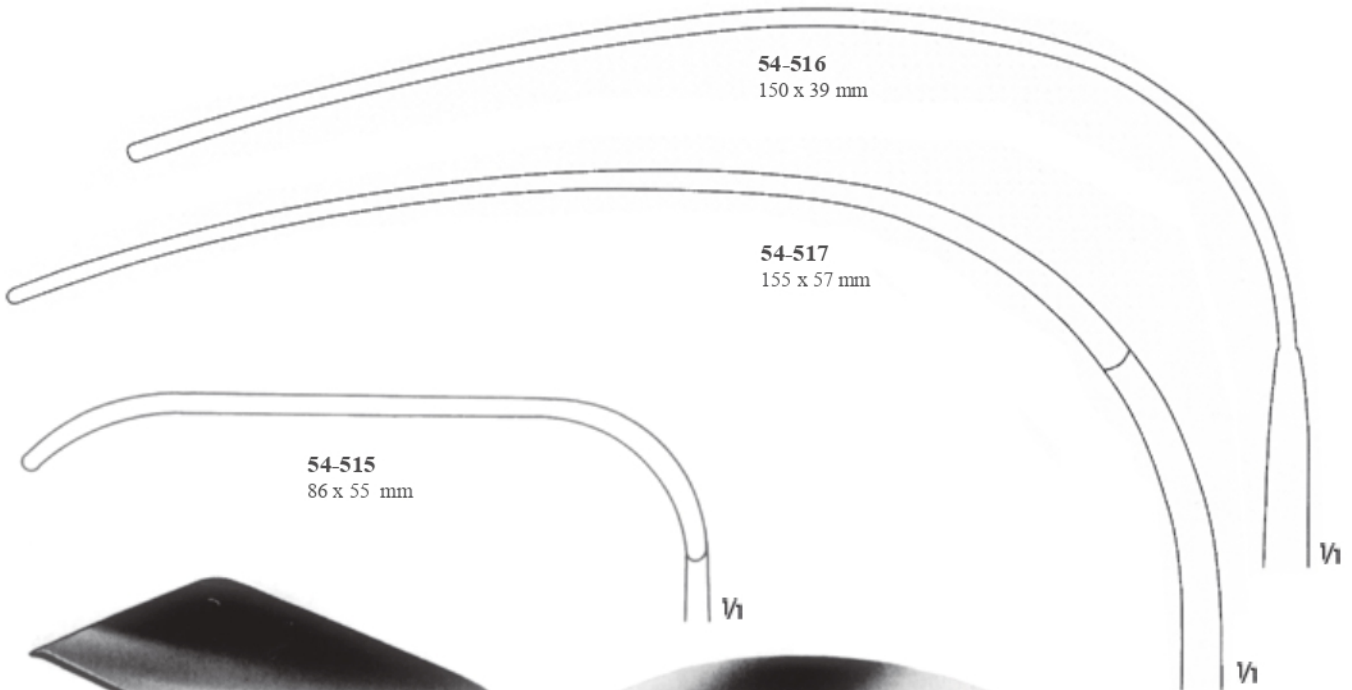

1/2
MIKULICZ
25.5 cm



1/2
KELLY
26 cm

Derin Cerrahi Ekartörler (Batın Ekartörleri)
 Retractors for Deep Surgery (Abdominal Retractors)

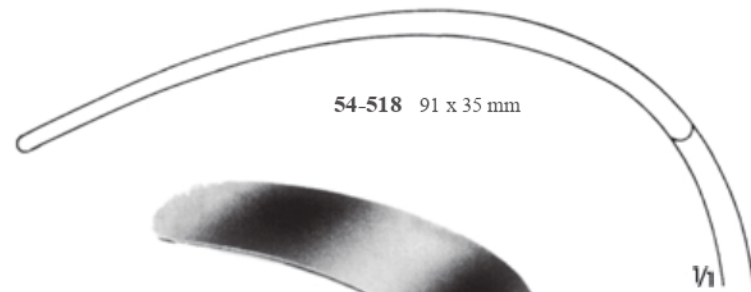
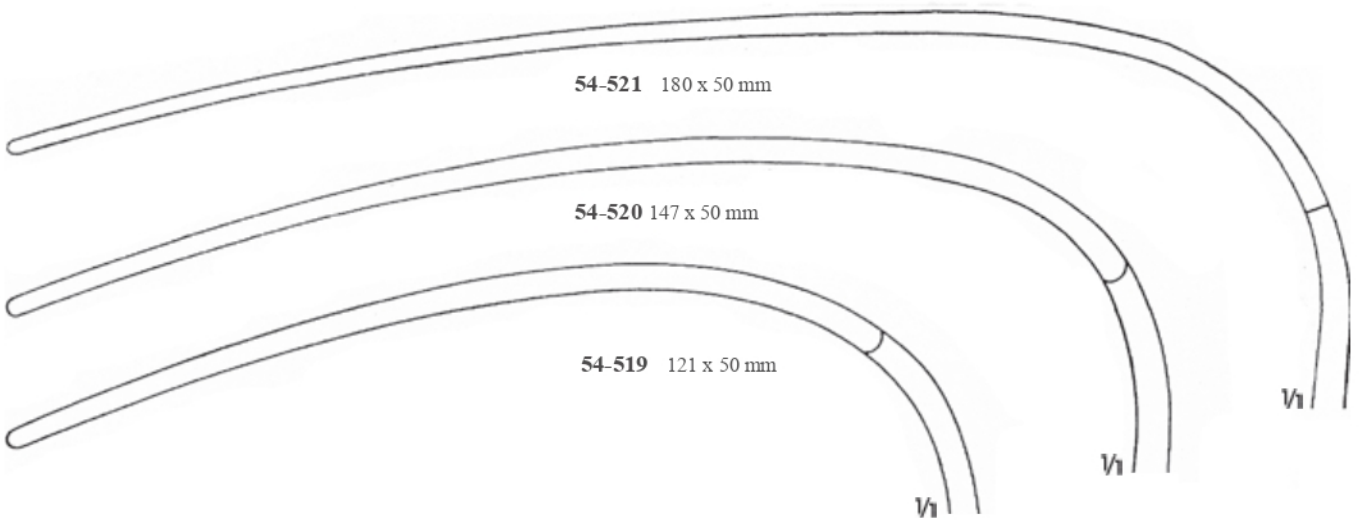

1/2
 MIKULICZ
 24 cm



1/2
 MIKULICZ
 54-519 - 54-520
 25 cm
 54-521
 26 cm





1/2

FRITSCH
24 cm

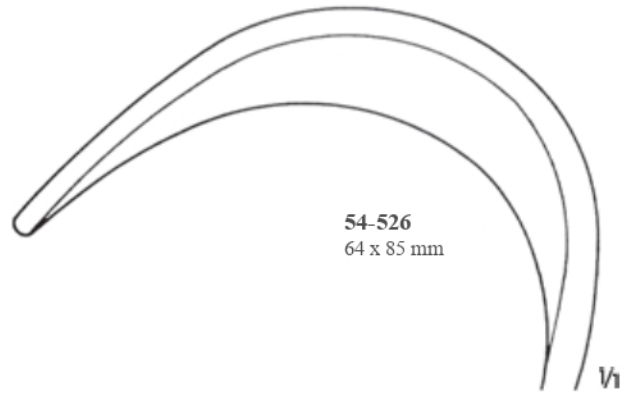

54-526
64 x 85 mm

1/1

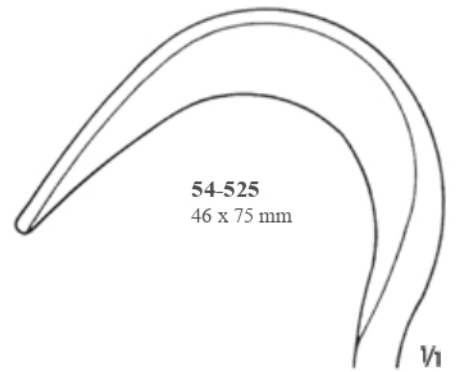

54-525
46 x 75 mm

1/1

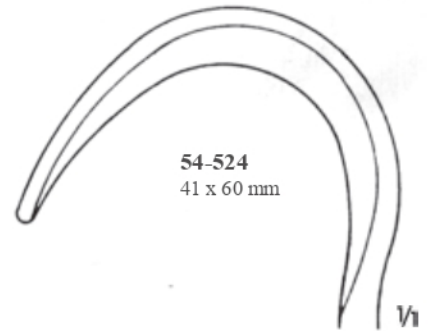

54-524
41 x 60 mm

1/1

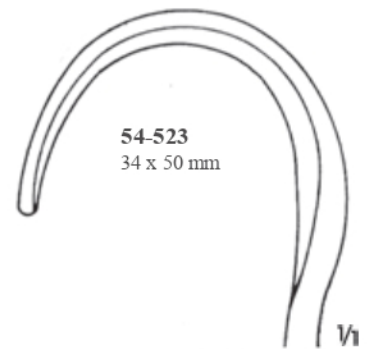

54-523
34 x 50 mm

1/1

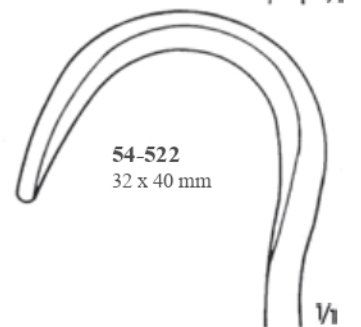

54-522
32 x 40 mm

1/1

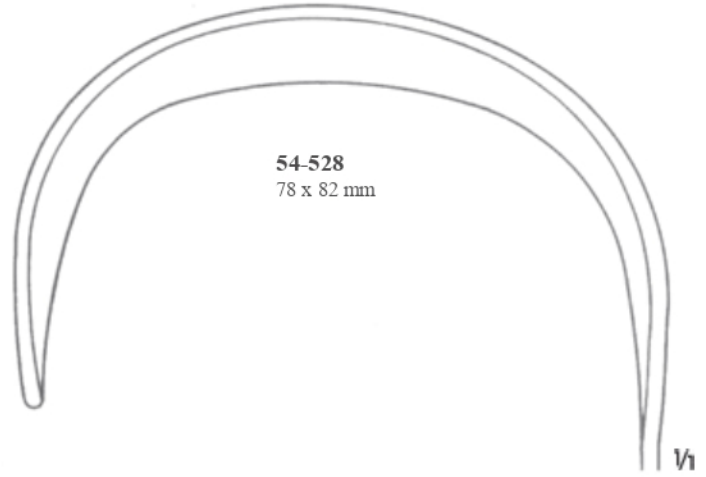
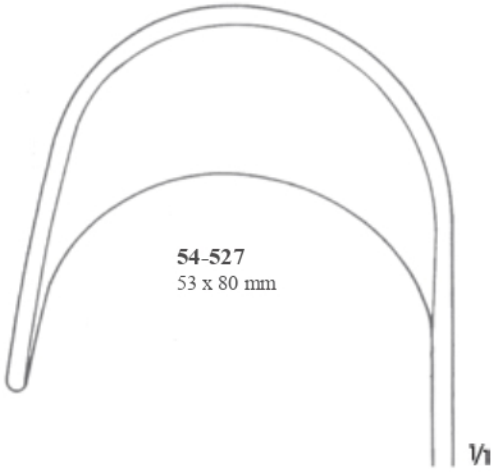



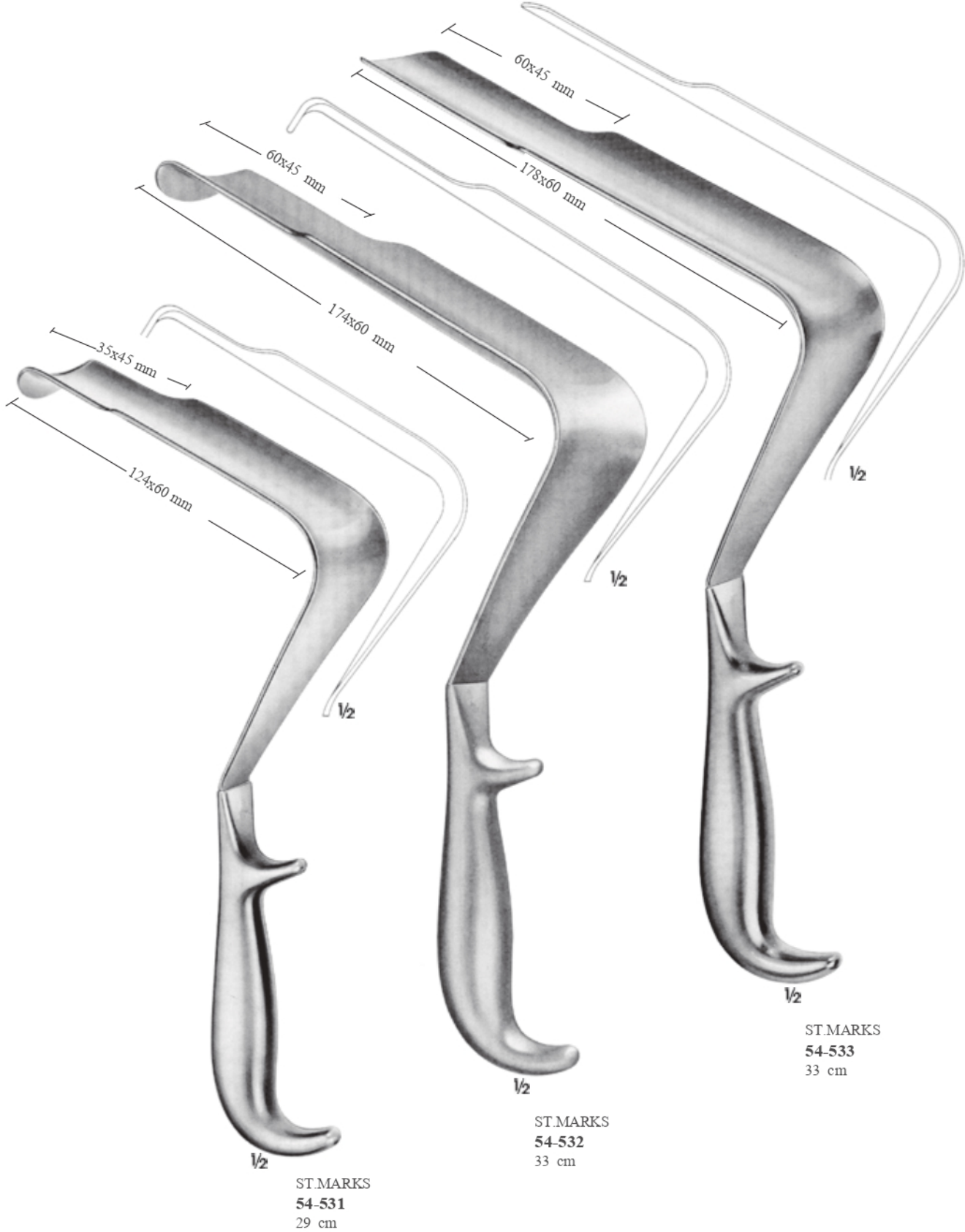

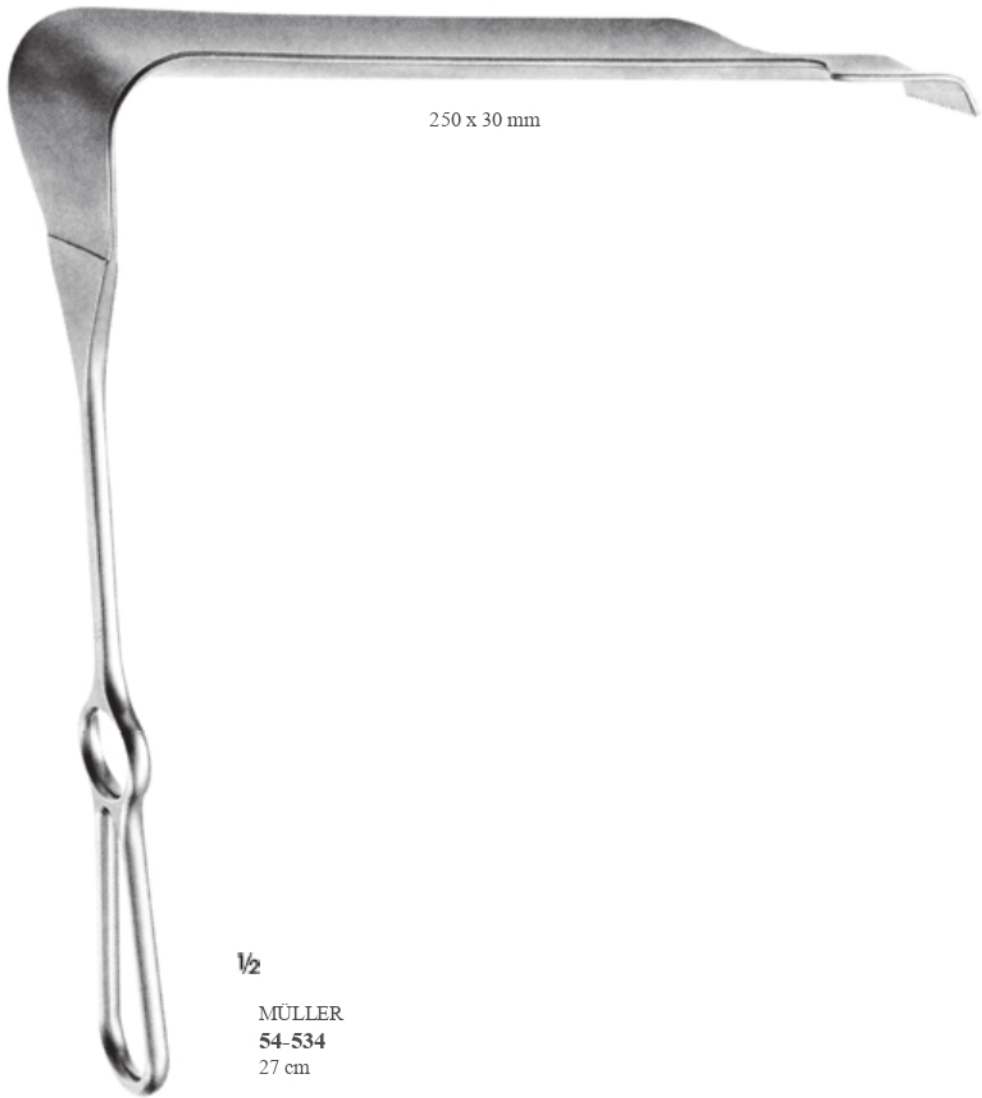

1/2

MÜLLER
54-534
27 cm



DOYEN
54-535
Işık taşıyıcılı/With light carrier
25 cm

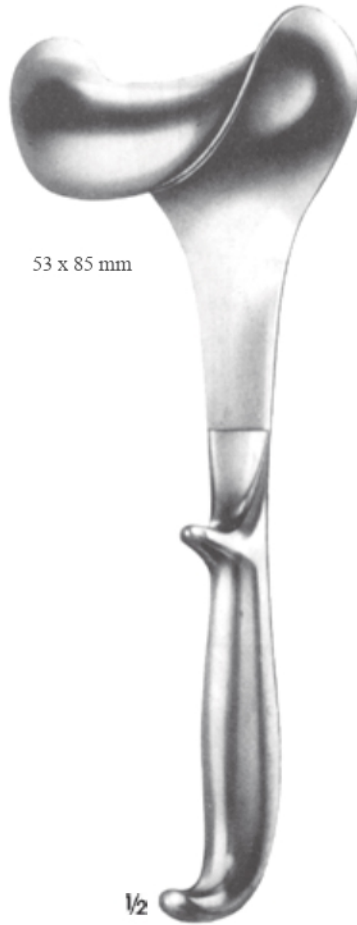

53 x 85 mm

DOYEN **54-536**
25 cm



MIKULICZ
54-537 120 x 50 mm
54-538 150 x 50 mm
Işık taşıyıcılı/With light carrier
26 cm



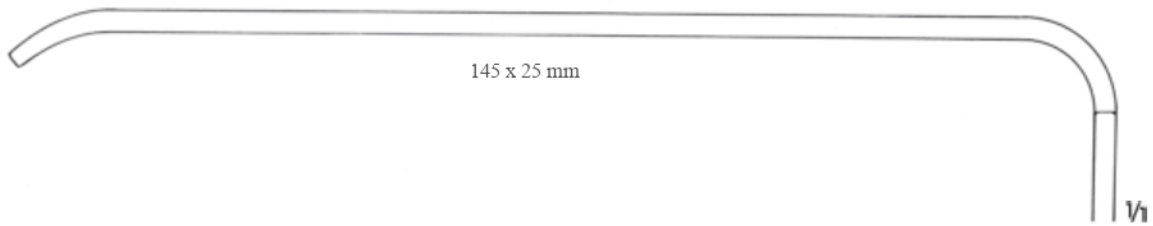

1/2

BRUNNER
54-539
Işık taşıyıcılı/With light carrier
24 cm



1/2

BRUNNER
54-540
24 cm

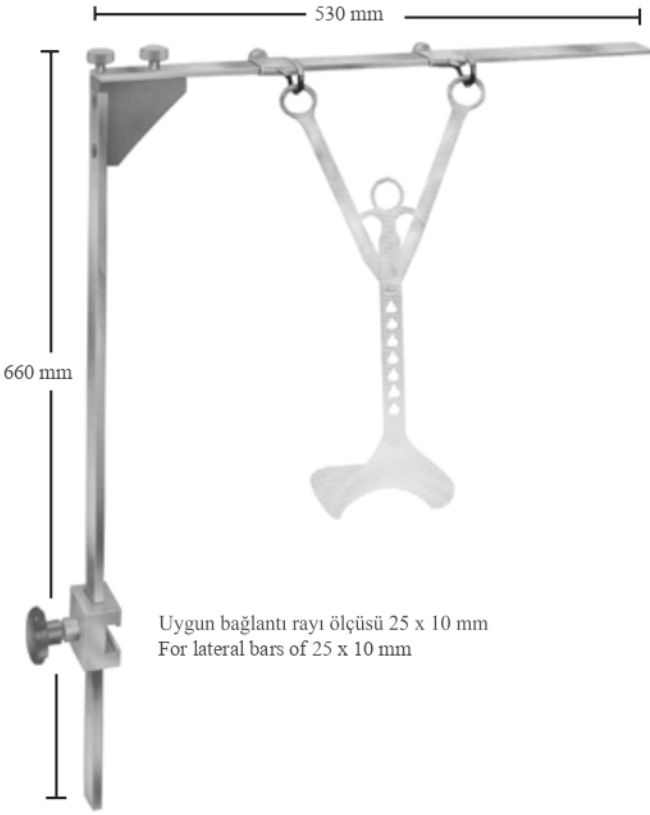

ROCHARD

54-541

Daha sağlam bağlantı oluşturmak üzere ameliyat masalarının her iki yan bağlantı rayına bağlanan montaj çerçevesi, sterilizasyon için sökülebilir.

Mounting frame for fastening to both sides of the lateral bars of the operating tables, thus more stability is given, can be dismantled for sterilization.

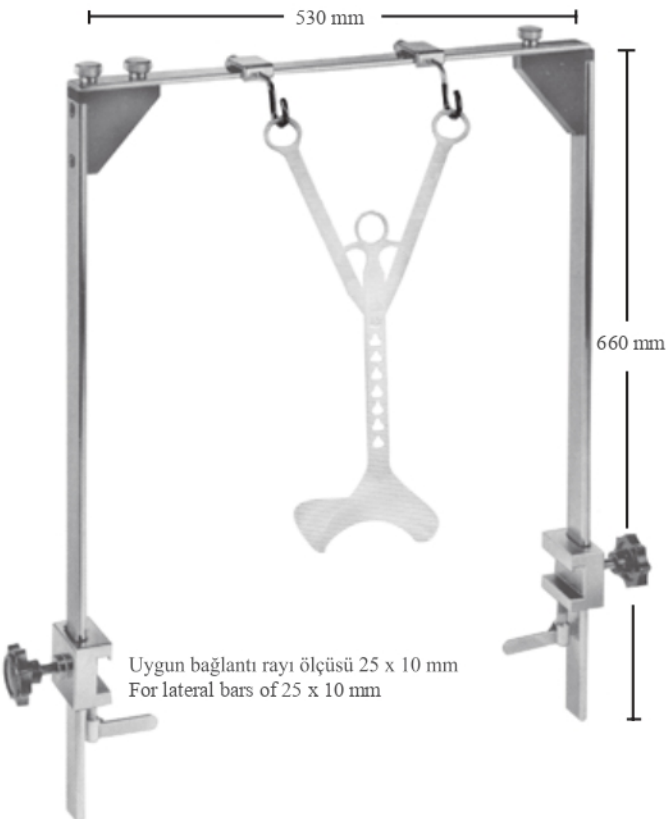

ROCHARD

54-542

Daha sağlam bağlantı oluşturmak üzere ameliyat masalarının her iki yan bağlantı rayına bağlanan montaj çerçevesi, sterilizasyon için sökülebilir.

Mounting frame for fastening to both sides of the lateral bars of the operating tables, thus more stability is given, can be dismantled for sterilization.



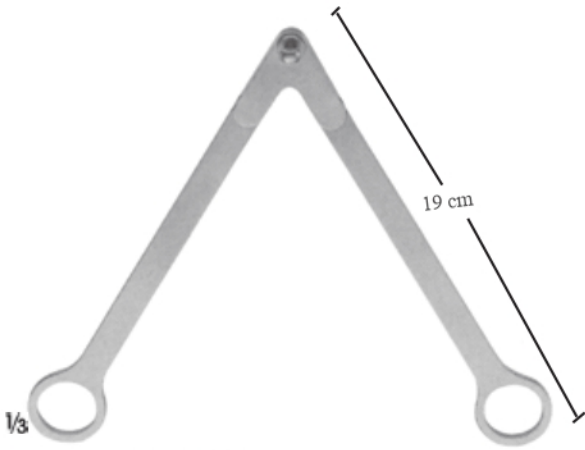

ROCHARD
54-543
Bağlantı tertibatı
Fixation device for



ROCHARD
54-544



54-545 Komple /Complete
Zincir/With chain
645 gr.)Ağırlık/Weighth
79 cm



DOYEN
54-546 48 x 90 mm
54-547 48 x 105 mm
54-548 48 x 120 mm
54-549 48 x 135 mm
28 cm



ROCHARD
54-550 48 x 90 mm
54-551 48 x 105 mm
54-552 48 x 120 mm
54-553 48 x 135 mm
54-554 48 x 155 mm
31 cm

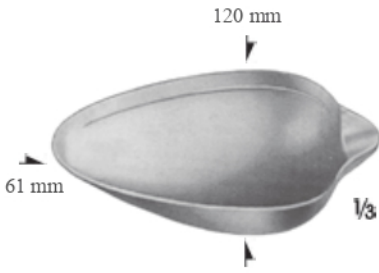

54-555
Kan kaşığı/Blood scoop
Hacmi 50 cc/Volume 50 cc



HABERER
54-556
Bükülebilir/
Malleable 30.5 cm



RIBBON
54-557 25 mm
54-558 30 mm
54-559 40 mm
54-560 50 mm
Bükülebilir/Malleable
33 cm



REVERDIN
54-561
28.5 cm



KOCHER
54-562
Kaşık şeklinde bastırıcı
Depressor, spoon shaped
22 cm



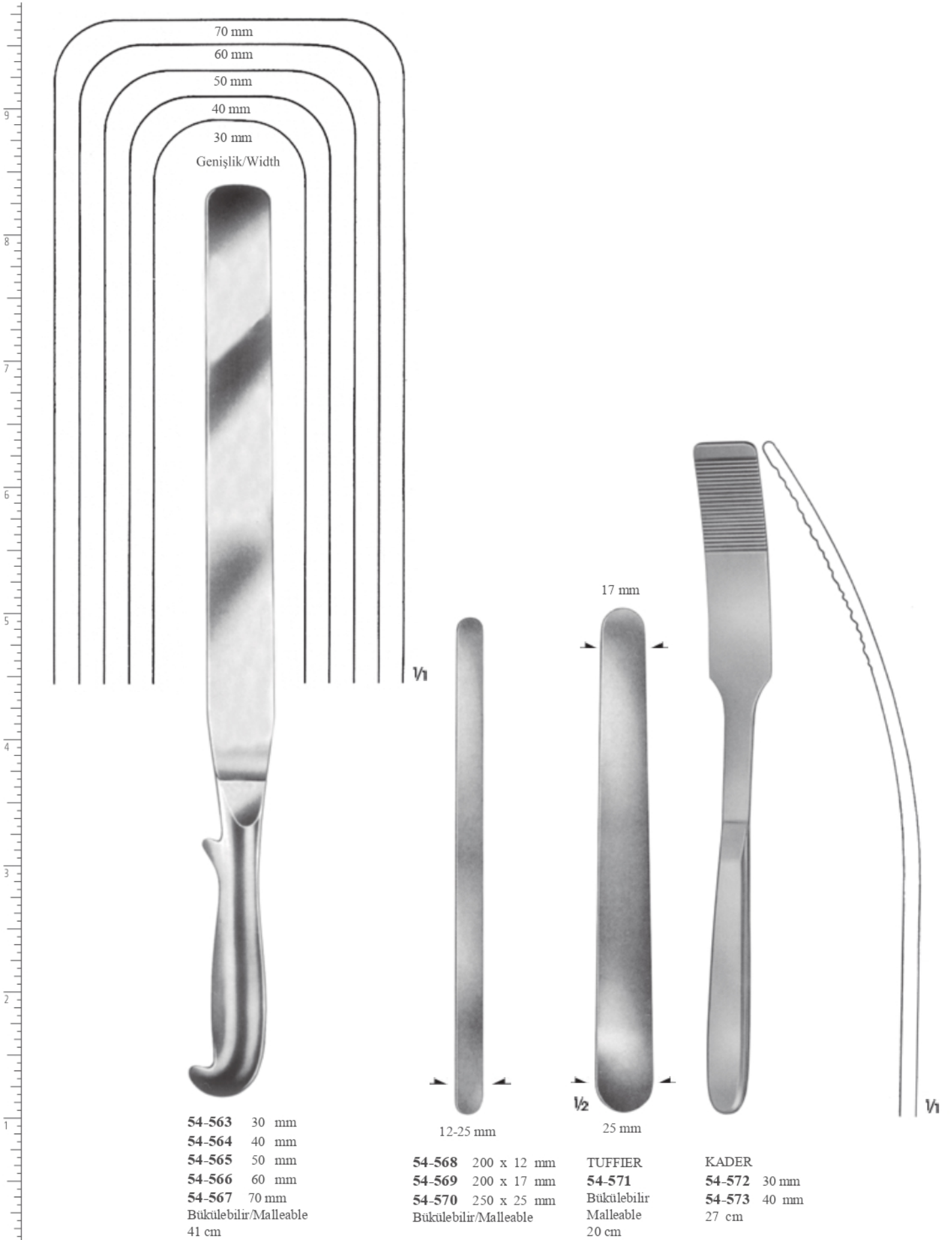

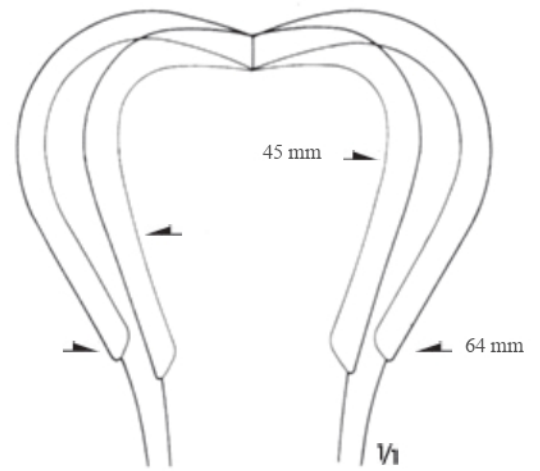
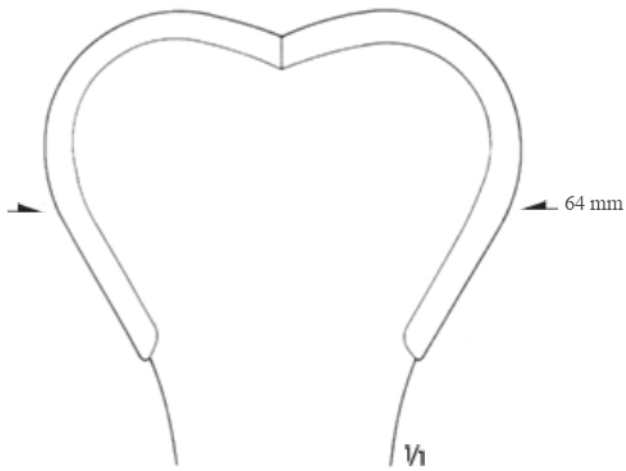

$\frac{1}{2}$
HARRINGTON-PEMBERTON
54-574 175 x 64 mm Esnek/
Flexible
29.5 cm

$\frac{1}{2}$
HARRINGTON
54-575 123 x 45 mm
54-576 123 x 64 mm
Esnek/Flexible
29.5 cm





1/2
ALLISON
54-577
25.5 cm



1/2
ALLISON
54-578
32 cm

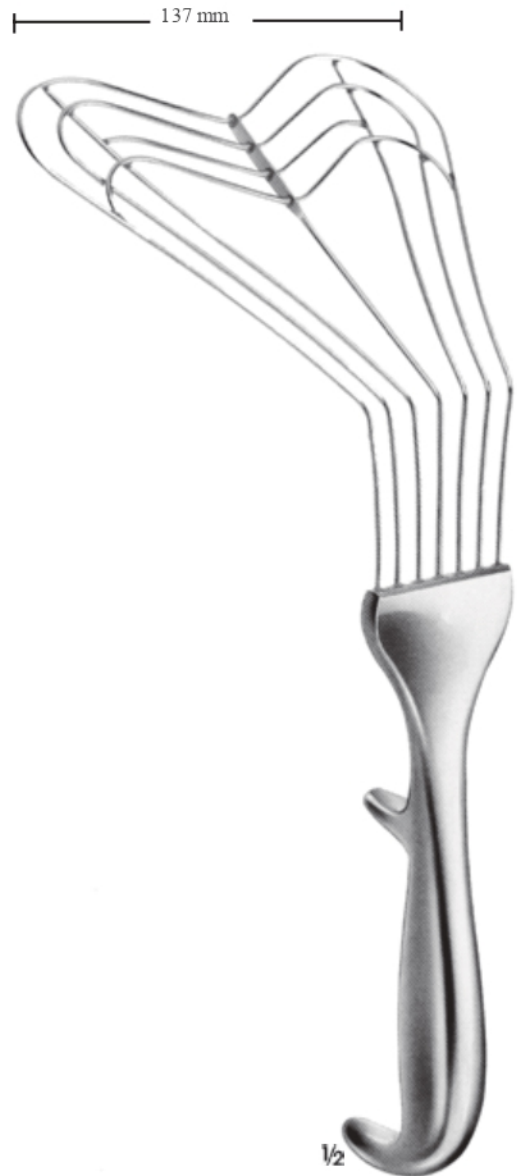

1/2
ALLISON
54-579
30 cm

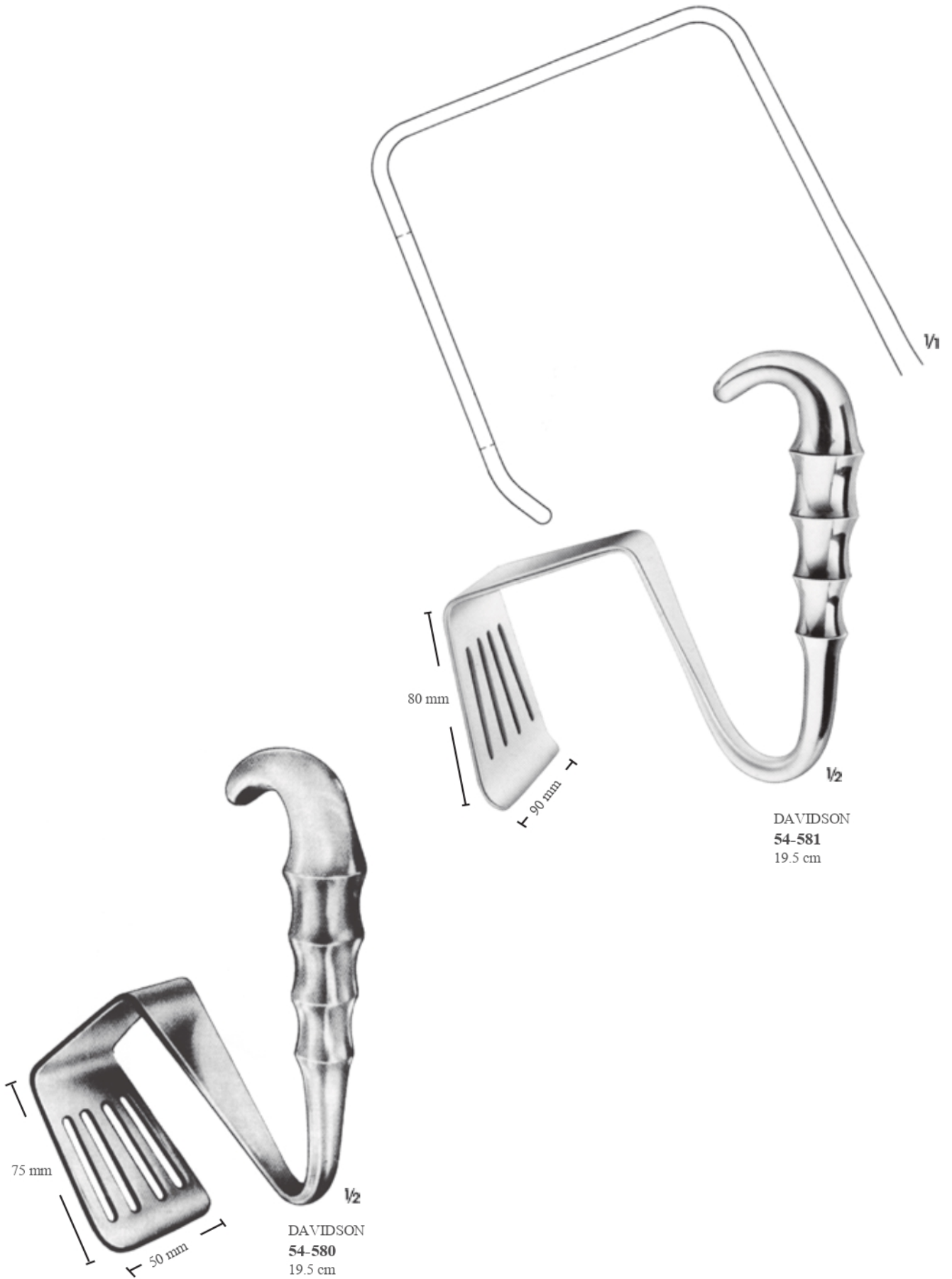



25 mm

1/2

DEAVER
54-582
23.5 cm



19 mm

1/2

DEAVER
54-583
18 cm



22 mm

1/2

DEAVER
54-584
21.5 cm



HASSON



1/2

54-585
10 x 160 mm

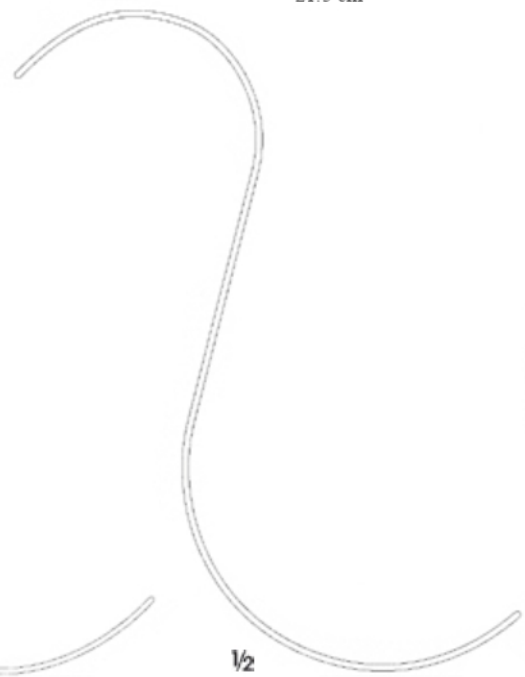

1/2

54-586
13 x 180 mm

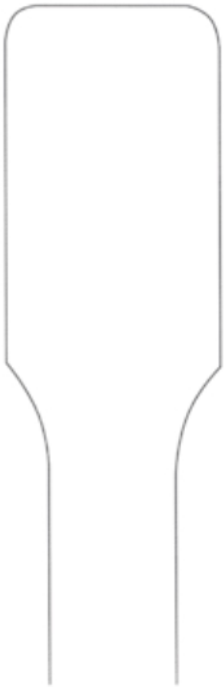

1/1



205 x 29 mm

1/2

54-587
26 cm



142 x 25 mm

1/2

BRUNNER
54-588
24 cm





ASCLASS

ASCLASS CERRAHİ ALETLER İMALAT SAN. VE TİC. LTD.ŞTİ

 [asclasscerrahialetler.ve.medya](https://www.instagram.com/asclasscerrahialetler.ve.medya)  [Asclass cerrahi aletler](https://www.facebook.com/Asclasscerrahi.aletler)  www.asclassgrup.com  info@asclassgrup.com - asclassmedya@gmail.com

 Çatalarmut Mahallesi Sezgin Sokak No:7 Kat:1/2/3 İlkadım/SAMSUN